

Theia[®]

TECHNOLOGIES



4K
12 MEGApix

**DAY
NIGHT**

TL1250
page 5



TL410
page 2



TL936
page 8

4K & Compatible Resolution Lenses
Fully Motorized, Compact Size
Superior NIR Correction





TL410 family 4K Resolution Day/Night lenses up to 1/1.7" sensors



- ✓ **Ultra high resolution for 4K cameras**, up to 12.4 megapixel, 300 lp/mm
- ✓ Available in DC **auto-iris**, **P-iris**, and **manual iris** versions
- ✓ **Fully motorized versions**, or combinations with zoom, focus, iris, IR cut, limit switch; non-motorized versions also available
- ✓ IR corrected from 435 – 940nm (true **Day/Night** cameras)
- ✓ **Compact design** to fit into domes as small as 4" mini-dome size
- ✓ **CS-mount, C-mount**, and smooth **Ø25mm board mount** options
- ✓ Used for sensor sizes 1/2.5", 1/2.3", 1/2", 1/1.8", and **up to 1/1.7"** (Sony IMX178, Sony IMX226 for example)

TL410 lens family specifications

Focal length	4-10mm
Image circle	Ø9.4mm
Resolution	12.4 megapixel, 300 lp/mm
F/#	F/1.4 @ 4mm – F/2.4 @ 10mm to close
Focus Range	0.5m to infinity
IR Correction	435nm – 940nm (Day/Night)
Lens length (TTL)	< 64mm
Back focal length	BFL 8.4mm (in air)
CRA	< 7°
Distortion	< 61% at 4mm, < 8% at 10mm
Relative illumination	>45%
Lens transmission	>80%
Weight	69-78g (depending on version)
Operating temperature	-20C to 60C (<70% humidity, non-condensing)
Storage temperature	-30C to 70C (<90% humidity, non-condensing)

Field of view for sensor sizes

Sensor size	1/1.7"	1/1.8"	1/1.8" 4K*	1/2"	1/2.3"	1/2.5"
Horizontal	112° - 44°	110° - 43°	110° - 43°	93° - 37°	90° - 36°	83° - 33°
Vertical	81° - 33°	71° - 29°	52° - 21°	68° - 28°	67° - 27°	60° - 25°
Diagonal	149° - 55°	139° - 52°	126° - 48°	120° - 46°	117° - 45°	106° - 42°

*4K format = 4000 x 2000 pixels

Lens designation

xx410x xx -xx

TL: motorized
SL: non-motorized
ML: C mount

A: autoiris
P: P-iris
M: manual iris

R3: motorized zoom, focus, iris
R4: motorized zoom, focus, iris, IRC
R5: motorized zoom, focus, iris, with limit switch for zoom, focus limits
R6: motorized zoom, focus, iris, IRC, with limit switch for zoom, focus limits

CS: CS mount
25: smooth \varnothing 25mm board mount
Blank: C mount

Production versions: (call for other versions)
SL410M-CS (manual lens, manual iris, CS mount)
SL410A-CS (manual lens, DC autoiris, CS mount)
SL410P-CS (manual lens, P-iris, CS mount)
ML410M (manual lens, manual iris, C mount)
TL410A R6-CS (fully motorized, DC autoiris lens)
TL410P R6-CS (fully motorized, P-iris lens)
TL410P R6-25 (fully motorized, P-iris, 25 mount)

Other versions are available by special request and may be added to production depending on volume.

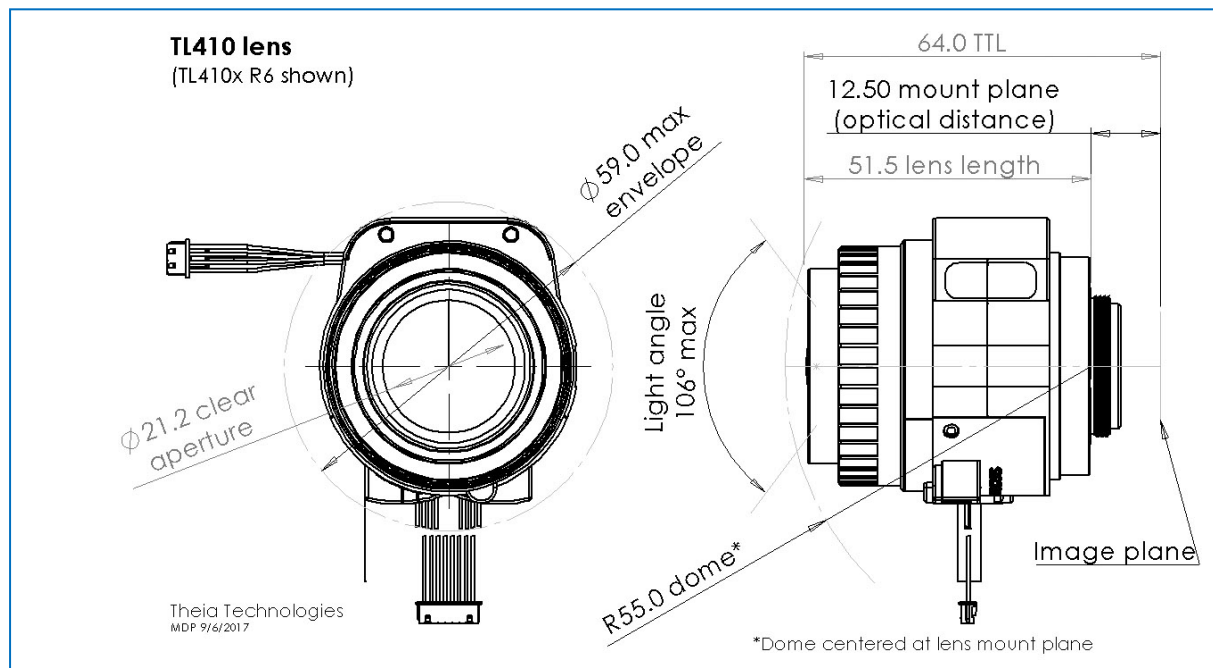

Representative drawing

Zoom/Focus motor specifications (TL410)

Drive	Stepper motor 2 phase bipolar drive			
Operation voltage	3.3V (operating range 2.6~4.8V)			
Maximum continuous operation time (seconds) for operation voltage and ambient temperature*		3.3V	4.0V	4.8V
	20C	200s	90s	50s
	40C	100s	60s	30s
	60C	40s	30s	15s
Coil resistance	28.5Ω (±7%)			
Gear ratio	1:2025			
Zoom number of steps	4073 steps between hard stops			
Zoom speed range	600pps to 1000pps*			
Zoom cam rotation	85°			
Focus number of steps	9354 steps between hard stops			
Focus speed range	600pps to 1000pps*			
Focus cam rotation	196°			
Focus/zoom connectors	Housing: Molex 51021-0800 Terminal: Molex 50058-8000			
Cable length	150mm			

Zoom: Wide -> Tele Focus: Near -> ∞				
Step	A+	A-	B+	B-
0	H	L	H	L
1	L	H	H	L
2	L	H	L	H
3	H	L	L	H

Pin	Color	Function	Motor
1	Brown	A+	Focus
2	Red	A-	Focus
3	Yellow	B+	Focus
4	Gray/Orange	B-	Focus
5	Brown	A+	Zoom
6	Red	A-	Zoom
7	Gray/Orange	B+	Zoom
8	Yellow	B-	Zoom

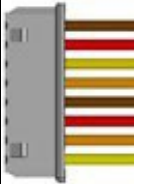

*Do not let motor temperature exceed 92°C. Download Theia's motor temperature calculator at theiatech.com/motortempcalc

Zoom/Focus motor step map (at infinite focus position). PI positions only available with -R5 and -R6 lenses.

Zoom motor		Focus motor	
Note	Step	Note	Step
Hard stop (wide)	4073	Hard stop (far)	9353
Wide design position	4073	Far focus design	8771
PI position	154	PI position	8652
Tele design position	0	Near focus design	188
Hard stop (tele)	0	Hard stop (near)	0

Zoom/Focus synchronizing map (observe min/max motor speeds)

Focal length	Zoom motor note	Zoom motor step number	Focus ring note	Focus motor step number
[mm]		[#]		[#]
4.15	Wide end	4073		288
4.96		3501		3149
5.77		2929		4892
6.58		2356		6125
7.39		1784		7687
8.19		1212		8599
9.00		640		8960
9.70		139		8931
9.90	Tele end	0		8871

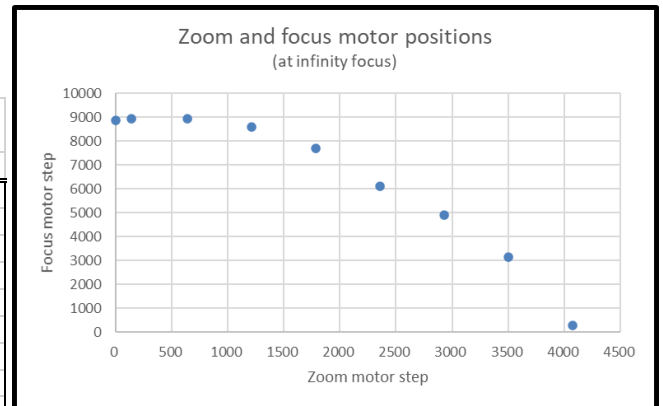

Notes:

1. Zoom and focus **motor positions may be affected** by backlash and lost steps during movement. Zoom motor lost steps are tested to <45 over the full 3934 step range. Focus motor lost steps are tested to <30 over the full 8464 step range.
2. These motorized lenses are intended for integration into cameras and require motor drivers and controllers. Typically, Theia works with the camera manufacturer to ensure that the camera motor controller matches the lens. It is possible to supply your own motor controller, but Theia cannot guarantee that your motor controller will not damage the lens. Theia does not offer any warranty on the suitability of these motorized lenses for any particular camera. These motorized lenses are **not intended for continuous use** of the motors as in PTZ applications. Theia offers motor control boards that are suitable to control motorized lenses with P-iris. See page 15 for more information.



TL1250 family 4K Resolution Day/Night lenses for 1/1.7" sensors



- ✓ **Ultra high resolution for 4K cameras**, up to 12.4 megapixel, 300 lp/mm
- ✓ Available in **DC autoiris**, **P-iris**, and **manual iris** versions
- ✓ **Fully motorized versions**, or combinations with zoom, focus, iris, IR cut, limit switch; non-motorized versions also available
- ✓ IR corrected from 435 – 940nm (true **Day/Night** cameras)
- ✓ **Compact design** to fit into domes as small as 4" mini-dome size
- ✓ **CS-mount** and smooth **Ø25mm board mount** options
- ✓ Used for sensor sizes 1/2.5", 1/2.3", 1/2" 1/1.8", and **up to 1/1.7"** (Sony IMX178, Sony IMX226 for example)

TL1250 lens family specifications

Focal length	12-50mm
Image circle	Up to Ø9.4mm
Resolution	12.4 megapixel, 300 lp/mm
F/#	F/1.8 @ 12mm - F/2.4 @ 50mm to close
IR Correction	435nm – 940nm (Day/Night)
Focus Range	2.0m - infinity
Lens length (TTL)	64mm
Back focal length	BFL 8.2mm (in air)
CRA	< 7°
Distortion	< 10% at 12mm, < 2% at 50mm
Relative illumination	>40%
Lens transmission	>80%
Weight	74g
Operating temperature	-20C to 60C (<70% humidity, non-condensing)
Storage temperature	-30C to 70C (<90% humidity, non-condensing)

Field of view for sensor sizes

Sensor size	1/1.7"	1/1.8"	1/1.8" 4K*	1/2"	1/2.3"	1/2.5"
Horizontal	36° - 8.6°	36° - 8.6°	35° - 8.5°	30° - 7.4°	30° - 7.2°	27° - 6.7°
Vertical	26° - 6.5°	23° - 5.8°	17° - 4.3°	23° - 5.6°	22° - 5.5°	20° - 5.0°
Diagonal	46° - 11°	44° - 10°	40° - 9.5°	39° - 9.2°	38° - 9°	34° - 8.3°

*4K format = 4000 x 2000 pixels

Lens designation

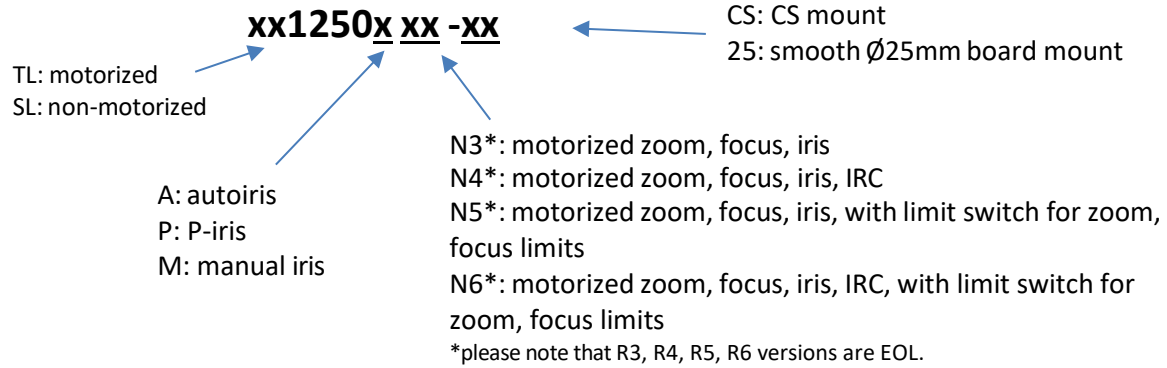

Production versions: (call for other versions)

- SL1250M-CS (manual lens, manual iris, CS mount)
- SL1250A-CS (manual lens, DC auto iris, CS mount)
- SL1250P-CS (manual lens, P-iris, CS mount)
- TL1250A N6-CS (fully motorized, DC auto iris lens)
- TL1250P N6-CS (fully motorized, P-iris lens)
- TL1250P N6-25 (fully motorized, P-iris lens, 25 mount)

Other versions are available by special request and may be added to regular production depending on volume.

Representative drawing

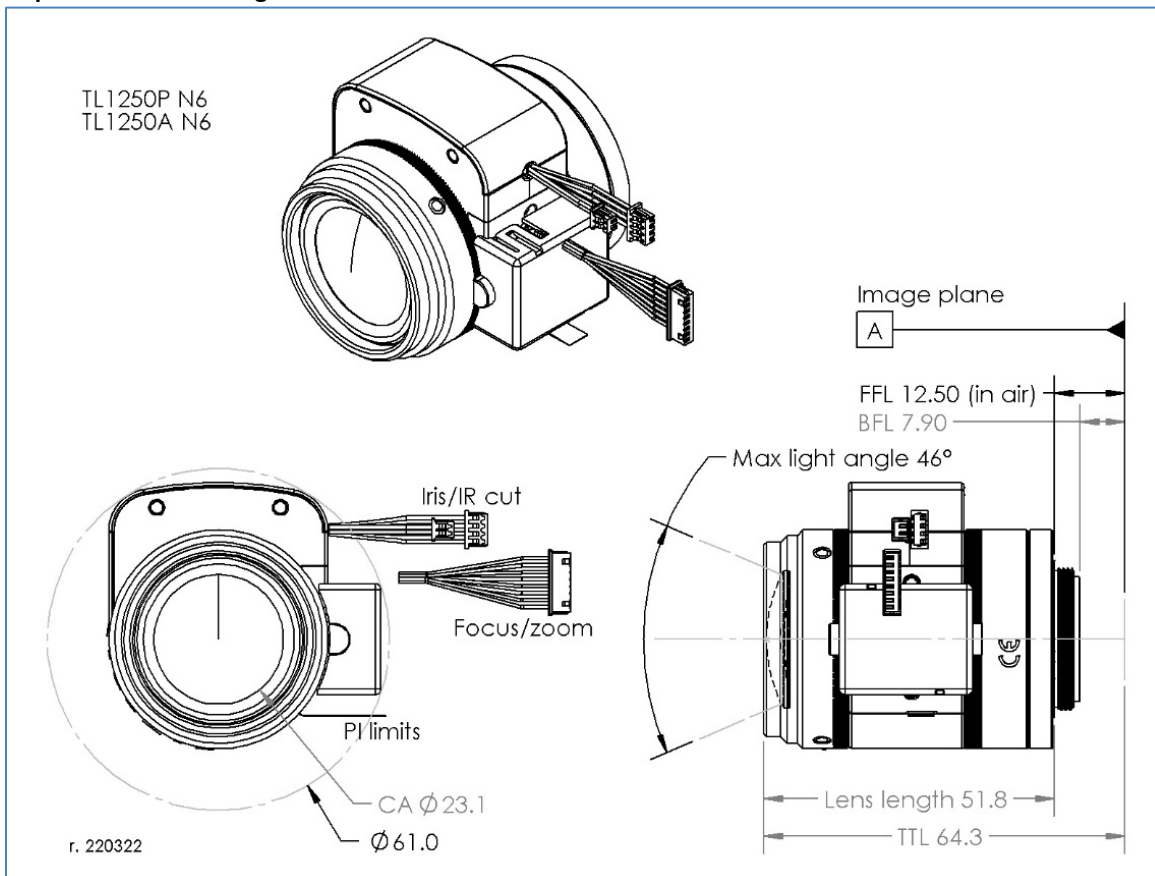

Zoom/Focus motor specifications

Drive	Stepper motor 2 phase bipolar drive
Operation voltage	3.3V (2.5-3.5V range)
Maximum motor temperature*	Do not let motor temperature exceed 120°C
Coil resistance	30.0Ω
Zoom number of steps	3227 steps between hard stops
Zoom speed range**	Up to 1200pps
Zoom cam rotation	75°
Focus number of steps	8390 steps between hard stops
Focus speed range**	Up to 1200pps
Focus cam rotation	195°
Focus/zoom connectors	Housing: Molex 51021-0800 Terminal: Molex 50058-8000
Cable length	150mm

Zoom: Wide -> Tele				
Focus: Near -> ∞				
Step	A+	A-	B+	B-
0	H	L	H	L
1	L	H	H	L
2	L	H	L	H
3	H	L	L	H

Pin	Color	Function	Motor
1	Brown	A+	Focus
2	Red	A-	Focus
3	Orange	B+	Focus
4	Yellow	B-	Focus
5	Brown	A+	Zoom
6	Red	A-	Zoom
7	Orange	B+	Zoom
8	Yellow	B-	Zoom

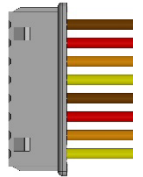

*Theia's motor temperature calculator can be used to estimate the focus and zoom motor temperatures after a set number of run/ cool down cycles. This can be downloaded from Theia's website (see the QR code below). These motorized lenses are **not intended for continuous use** of the motors as in PTZ applications due to potential over-heating of the lens motors.

The example below shows 60C ambient temperature and 3.5V motor. The motor is driven for 30 seconds (which would generally be longer than normal) with 10 seconds cool down between moves. After 3 moves, the motor is allowed to cool down which takes about 3 minutes.

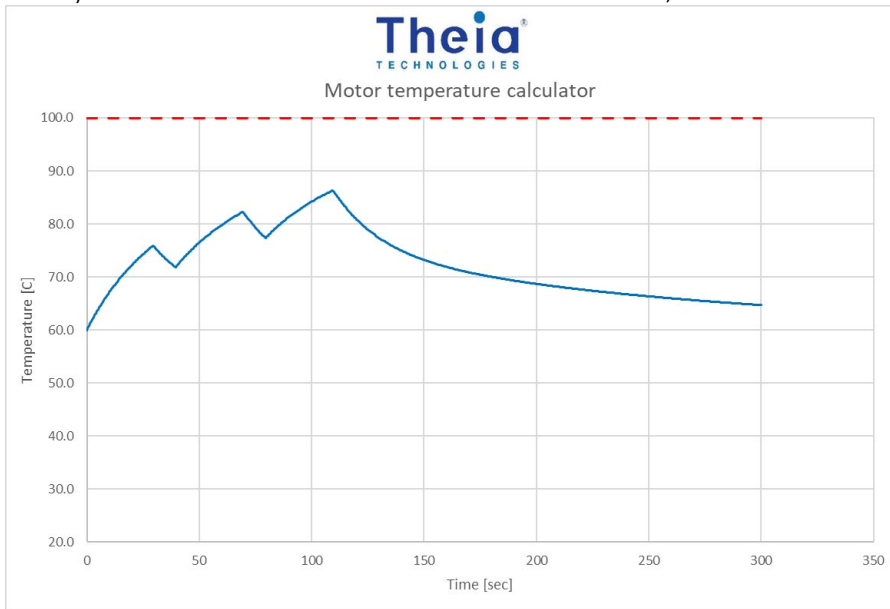

Motor temperature calculator
TheiaTech.com/calculators

**Zoom and focus motor positions may be affected by backlash and lost steps during movement. Lost steps are affected by the driving conditions. It is best to drive the motor between 200pps and 1200pps with 4-12 steps of acceleration/deceleration. Acceleration is especially helpful at higher driving speeds. Within these limits, the lost steps should be <5 steps per full zoom/focus range.

Backlash is variable from lens to lens but should be consistent for each movement of the lens motors. For zoom, expected backlash is approximately 15-20 steps and for focus it is approximately 30-40 steps.

Zoom/Focus motor key steps.

Zoom motor		Focus motor	
<i>Note</i>	<i>Step</i>	<i>Note</i>	<i>Step</i>
Hard stop (wide)	3227	Hard stop (far)	8390
Wide design position	3227	Far focus design	8067
PI position	3119	PI position	7959
Tele design position	0	Near focus design	323
Hard stop (tele)	0	Hard stop (near)	0

Zoom/Focus synchronizing map (observe min/max motor speeds). Due to internal lens variations and back focal length variations in the camera the observed focus motor step will be different than the design position shown below. The lens can be calibrated at a fixed focus/zoom point (infinite object distance and wide angle is best). This focus step difference can be used to offset the design curve at all focal lengths to find the corrected zoom/focus curve for the lens.

Focal length	Zoom motor note	Zoom motor step number	Focus motor step number
<i>[mm]</i>		<i>[#]</i>	<i>[#]</i>
12.36	Wide end	3227	3008
14.83		2710	2117
18.05		2194	1356
22.28		1678	895
27.86		1161	1046
35.20		645	2413
49.00	Tele end	0	8067

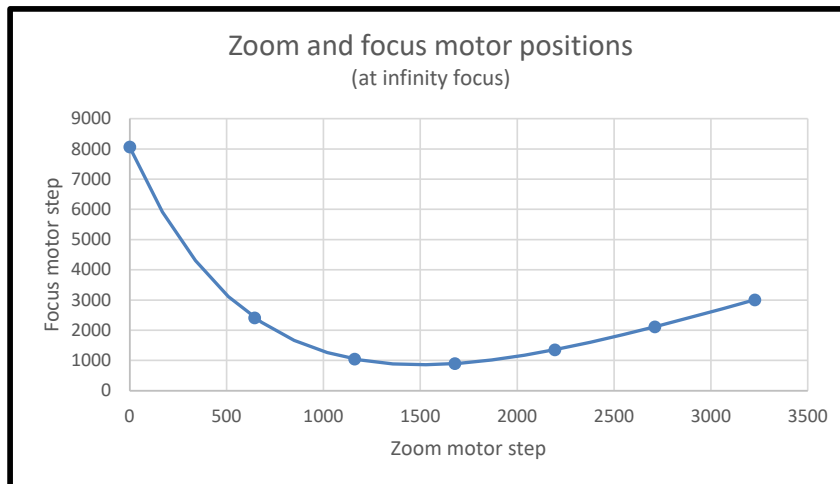

Notes:

These motorized lenses are intended for integration into cameras and require motor drivers and controllers. Typically, Theia works with the camera manufacturer to ensure that the camera motor controller matches the lens. It is possible to supply your own motor controller, but Theia cannot guarantee that your motor controller will not damage the lens. Theia does not offer any warranty on the suitability of these motorized lenses for any particular camera. Theia offers motor control boards that are suitable to control motorized lenses with P-iris. See page 15 for more information.



TL936 Motorized Telephoto Day/Night 4K Compatible Megapixel Lens



9mm



36mm

- ✓ Compatible with 4K cameras (1/2.3" Sony IMX172 for example) with **5+ megapixel resolution, 200+ lp/mm** for demanding applications
- ✓ **Fully motorized versions**, or combinations with zoom, focus, iris, IR cut, and limit switch
- ✓ **4x zoom**: 9-36mm for long reach and field of view optimization
- ✓ Available in DC **auto-iris** and **P-iris** versions
- ✓ IR corrected from 435 – 940nm (true **Day/Night** cameras)
- ✓ **Compact** design (< 50mm TTL) to fit into domes as small as 4" mini-dome size
- ✓ CS-mount and smooth D25 board mount options
- ✓ For 1/3", 1/2.7" HD, 1/2.5" and 1/2.3" 4K* sensors

TL936 lens family specifications

Focal length	9-36mm
Resolution	5+ megapixel, 200+ lp/mm
F/#	F/1.5 to close
IR Correction	435 – 940 nm (Day/Night)
Lens length	<50mm
Focus range	2.5m - infinity
Operating temperature	-20C to 60C (<70% humidity, non-condensing)
Storage temperature	-20C to 70C (<90% humidity, non-condensing)
CS mount slip range	320°

Field of view for sensor sizes

Sensor size	1/3"	1/2.7" HD	1/2.5"	1/2.3" 4K*
Field of view (H)	30° - 7.1°	37° - 8.6°	36° - 8.5°	39° - 10°
Field of view (V)	22° - 5.3°	20° - 4.8°	27° - 6.3°	19° - 5.0°
Field of view (D)	38° - 8.8°	42° - 9.9°	46° - 10.6°	44° - 11°

*4K format 4000x2000 pixels

Lens designation

TL936x xx -xx

CS: CS mount
25: smooth $\varnothing 25\text{mm}$ board mount

A: autoiris
P: P-iris

R3: motorized zoom, focus, iris
R4: motorized zoom, focus, iris, IRC
R5: motorized zoom, focus, iris, with limit switch for zoom, focus limits
R6: motorized zoom, focus, iris, IRC, with limit switch for zoom, focus limits

Production versions (call for other version):

TL936A R6-CS TL936P R6-CS TL936P R6-25
TL936A R5-CS TL936P R4-CS
TL936A R4-CS TL936P R3-CS

Other versions are available by special request and may be added to regular production depending on volume.

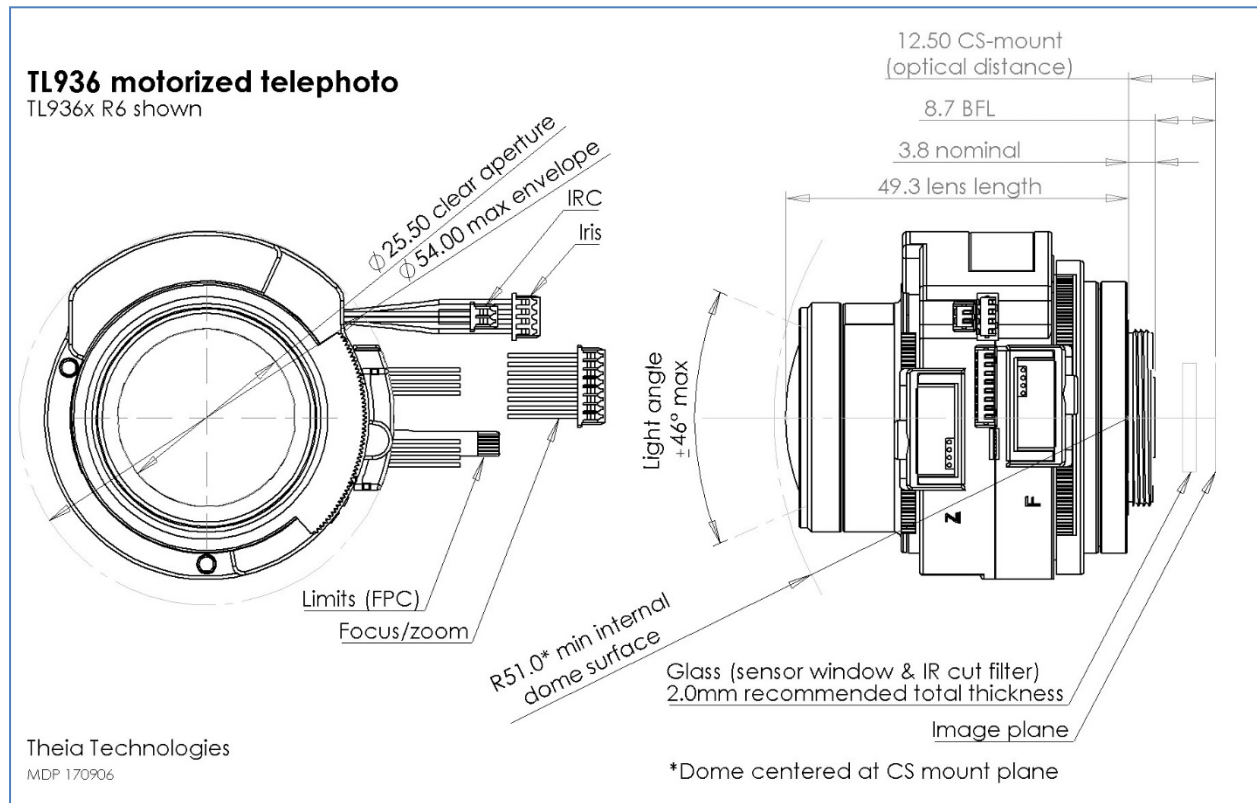

Representative drawing

Zoom/Focus motor specifications (TL936)

Drive	Stepper motor 2 phase bipolar drive			
Operation voltage	3.3V (operating range 2.6~4.8V)			
Maximum continuous operation time (seconds) for operation voltage and ambient temperature*		3.3V	4.0V	4.8V
	20C	200s	90s	50s
	40C	100s	60s	30s
	60C	40s	30s	15s
Coil resistance	28.5Ω ±7%			
Gear ratio	1:2308			
Zoom number of steps	2994 steps between hard stops			
Zoom speed range	600pps to 1000pps*			
Zoom cam rotation	57°			
Focus number of steps	5180 steps between hard stops			
Focus speed range	600pps to 1000pps*			
Focus cam rotation	100°			
Focus/zoom connectors	Housing: Molex 51021-0800 Terminal: Molex 50058-8000			
Cable length	150mm			

Zoom: Wide -> Tele Focus: Near -> ∞				
Step	A+	A-	B+	B-
0	H	L	H	L
1	L	H	H	L
2	L	H	L	H
3	H	L	L	H

Pin	Color	Function	Motor
1	Brown	A+	Focus
2	Red	A-	Focus
3	Gray	B+	Focus
4	Yellow	B-	Focus
5	Brown	A+	Zoom
6	Red	A-	Zoom
7	Gray	B+	Zoom
8	Yellow	B-	Zoom

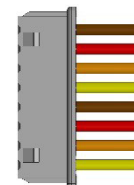

*Do not let motor temperature exceed 92°C. Download Theia's motor temperature calculator at theiatech.com/motortempcalc

Zoom/Focus motor step map (at infinite focus position)

Zoom motor			Focus motor		
Note	Step (-R5, -R6)	Step (-R3, -R4)	Note	Step (-R5, -R6)	Step (-R3, -R4)
Hard stop (wide)	-36	0	Hard stop (far)	-52	0
Wide design position	-26	10	Far focus design	-26	26
PI (1) position	0	NA	PI (1) position	0	NA
PI (2) position	2923	NA	PI (2) position	5077	NA
Tele design position	2949	2985	Near focus design	5103	5155
Hard stop (tele)	2959	2995	Hard stop (near)	5129	5181

Zoom/Focus synchronizing map (step numbers based on -R5, -R6 lenses, observe min/max motor speeds)

Focal length [mm]	Zoom motor note	Zoom motor step number [#]	Focus motor step number [#]
9.27	Wide end	-26	2631
12.19		696	1743
15.3		1238	1186
19.47		1764	898
24.56		2245	1117
30.86		2689	2138
35.45	Tele end	2949	3353

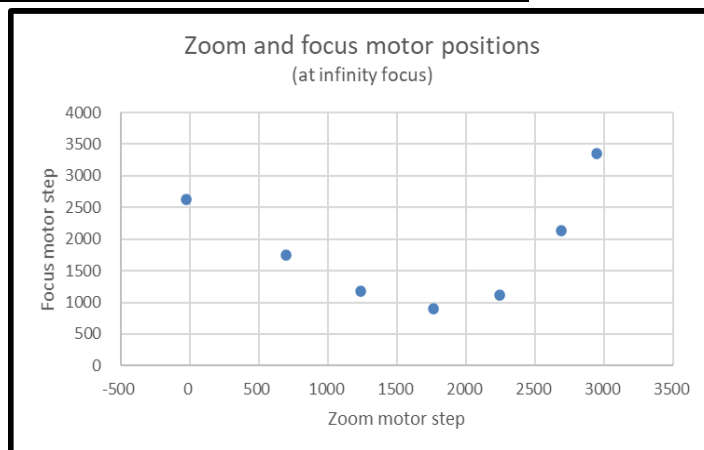

Notes:

1. Zoom and focus **motor positions may be affected** by backlash and lost steps during movement. Zoom motor lost steps are tested to <20 over the full 2923 step range. Focus motor lost steps are tested to <20 over the full 5077 step range.

2. These motorized lenses are intended for integration into cameras and require motor drivers and controllers. Typically, Theia works with the camera manufacturer to ensure that the camera motor controller matches the lens. It is possible to supply your own motor controller, but Theia cannot guarantee that your motor controller will not damage the lens. Theia does not offer any warranty on the suitability of these motorized lenses for any particular camera. These motorized lenses are **not intended for continuous use** of the motors as in PTZ applications. Theia offers motor control boards that are suitable to control motorized lenses with P-iris. See page 15 for more information.

Common Motorized Lens Specifications

Theia's motor temperature calculator can be used to estimate the focus and zoom motor temperatures after a set number of run/ cool down cycles. This can be downloaded from Theia's website (see the QR code below).

Motors require 5 minutes to cool down completely to ambient temperature. Do not let motor temperature exceed 92°C.

The example below shows 60C ambient and 4V motor driven at 1000pps. Motors reach maximum temperature in <30 seconds and should be allowed to cool down. If the motor is run again before complete cool down it will reach maximum temperature in <30 seconds.

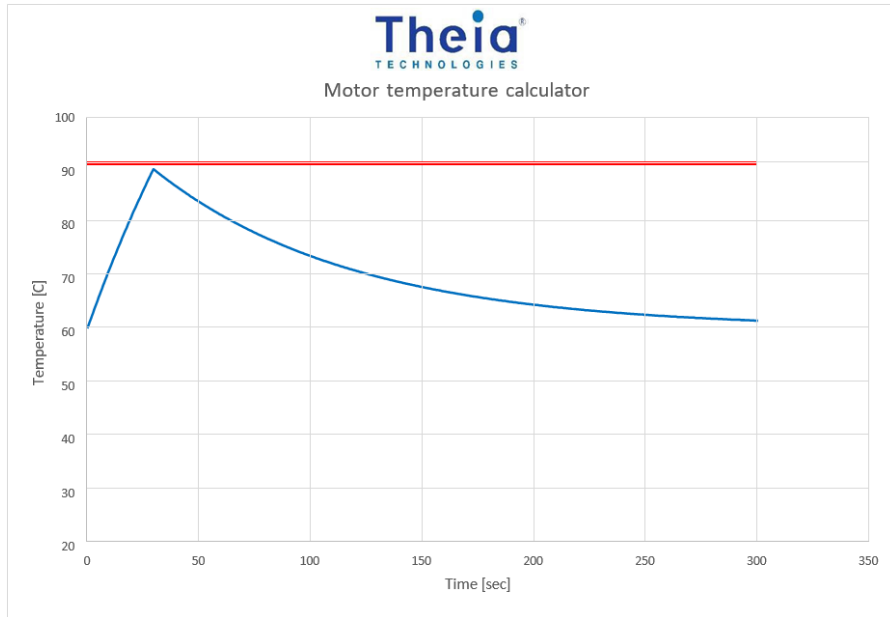
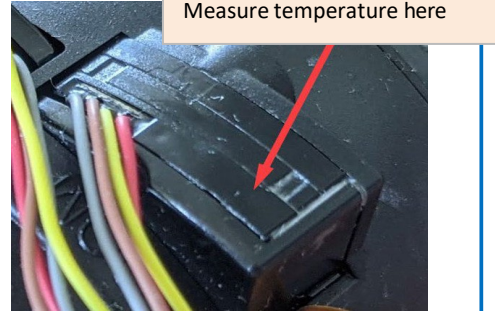

Motor temperature calculator
TheiaTech.com/motortempcalc

Zoom/Focus limit switch

Applicable models: TLxxxA R/N5, TLxxxP R/N5, TLxxxA R/N6, TLxxxP R/N6

Type	Photo interrupter phototransistor
Part model	Sharp GP1S396HCPSF
Operating voltage	3.3V
Output level	>2.2V HIGH <0.6V LOW
Connector type	FPC cable
Board-side mating connector type (not supplied)	Molex 52746-0671 Molex 52745-0697 Molex 52559-0652
Cable length	150mm

Recommended circuit for each photo interrupter

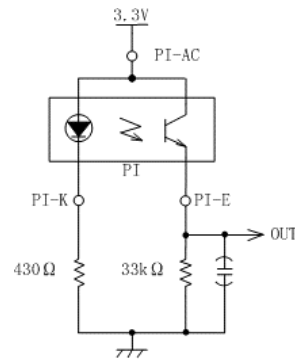

Pin*	Function	Motor
1	Emitter	Focus
2	Anode/Collector	Focus
3	Cathode	Focus
4	Emitter	Zoom
5	Anode/Collector	Zoom
6	Cathode	Zoom



*cable side pin designation matches Molex 52746-0671 bottom side contacts connector

DC autoiris motor specifications

Applicable models: TLxxxA R/N3, TLxxxA R/N4, TLxxxA R/N5, TLxxxA R/N6

Drive	DC
Operation voltage	3V (2.5~5.0V)
Max current consumption	26mA
Drive coil resistance	190Ω ±10%
Damper coil resistance	855Ω ±7%

DC Auto iris control is the responsibility of the camera manufacturer; Theia motor control board (see p. 15) does not control the DC auto iris, only the P-iris.

Applicable models: TLxxxA R/N4, TLxxxA R/N6

Connector type 1	Molex
Connector type	Housing: Molex 51021-0400 Terminal: Molex 50058-8000
Cable length	150mm

Pin	Color	Function
1	Brown	Control -
2	Red	Control +
3	Yellow	Drive +
4	Orange	Drive -



Applicable models: TLxxxA R/N3, TLxxxA R/N5

Connector type 2	CCTV
Connector type	Housing: EYC 221
Cable length	300mm

Pin	Function
1	Control -
2	Control +
3	Drive +
4	Drive -

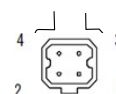

P-iris motor specifications

Applicable models: TLxxxP R/N3, TLxxxP R/N4, TLxxxP R/N5, TLxxxP R/N6

Drive	Stepper motor 2 phase bipolar drive
Operating voltage	4V (2.7~5.0V)
Number of steps	Step 1: stop Step 2: Full open Step 72: Full close Step 75: stop
Basic step angle	18°
Maximum response freq.	200pps
Coil resistance	30Ω ±10% (each phase)

P-iris: open->close				
Step	A+	A-	B+	B-
0	H	L	H	L
1	L	H	H	L
2	L	H	L	H
3	H	L	L	H

Applicable models: TLxxxP R/N4, TLxxxP R/N6

Connector type 1	Molex
Connector type	Housing: Molex 51021-0400 Terminal: Molex 50058-8000
Cable length	150mm

Pin	Color	Function
1	Brown	B+
2	Red	B-
3	Yellow	A+
4	Orange	A-

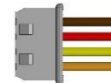

Applicable models: TLxxxP R/N3, TLxxxP R/N5

Connector type 2	CCTV
Connector type	Housing: EYC 221
Cable length	300mm

Pin	Function
1	B+
2	A+
3	A-
4	B-

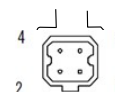

P-iris motor map (TL410)

Step	Aperture Size [mm2]	F/#
1	65.0	1.43 (open)
19	65.0	1.43 (open)
20	63.4	1.50
25	54.0	1.63
30	44.9	1.78
35	36.0	1.98
40	27.7	2.26
45	20.0	2.65
50	13.2	3.26
55	7.5	4.34
60	3.1	6.71
65	0.8	12.86
70	0.1	46.06
72	0.0	Closed

P-iris motor map (TL1250)

Step	Aperture Size [mm2]	F/#
1	95.0	1.84
5	90.8	1.88
10	82.1	1.98
15	72.8	2.10
20	63.4	2.25
25	54.0	2.43
30	44.9	2.67
35	36.0	2.98
40	27.7	3.39
45	20.0	3.98
50	13.2	4.90
55	7.5	6.52
60	3.1	10.10
65	0.8	19.34
70	0.1	69.29
72	0.0	Closed

P-iris motor map (TL936)

Step	Aperture Size [mm2]	F/#
1	95.0	1.54
5	90.8	1.54
10	82.1	1.61
15	72.8	1.71
20	63.4	1.83
25	54.0	1.98
30	44.9	2.17
35	36.0	2.42
40	27.7	2.76
45	20.0	3.24
50	13.2	3.98
55	7.5	5.30
60	3.1	8.20
65	0.8	15.71
70	0.1	56.29
72	0.0	Closed

IR Cut Specifications

Applicable models: TLxxxA R/N4, TLxxxP R/N4, TLxxxA R/N6, TLxxxP R/N6

Electrical specifications	
Drive	DC
Operating voltage	4.0V
Drive coil resistance	130Ω
Connector type	Housing: Molex 51021-0200 Terminal: Molex 50058-8000
Cable length	150mm
Optical specifications for IR filter (Day)	
Cut-on wavelength	405nm ±10nm
Visible transmission	430-610nm
Cut-off wavelength	650nm ±10nm
IR transmission	<5% max 700-1000nm <10% ave 1000-1100nm
Optical specifications for clear filter (Night)	
Visible transmission	400-1050nm

Mode	Pin 1	Pin 2
Day (IR filter)	L	H
Night (clear filter)	H	L
Wire color	Red	Black

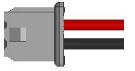

Optional Filter Configurations

TLXXX x### x X6 -xx



Lens	Iris type	IR wavelength*	Alternate filter type*	Motors	Mount type
TL1250 TL936 TL410	A: DC autoiris P: P-iris	850: notch filter 940: long wave pass filter	V: IR blocking, visible transmitting C: clear glass, visible and IR transmitting	R6 N6	(blank): C mount CS: CS mount 25: Ø25mm board mount

* see spectral graphs for wavelength transmission characteristics

Not all options are available; call for lead times and availability

Typical models include: TL1250P-940V N6 CS, TL1250P-940C N6 CS, TL1250A-940V R6 CS

Filter Optical Specifications

IR-only filter specifications Applicable models: TLXXXx-850x

Type	Notch filter for 850nm illumination
Spectrum	TBDnm: t=50% 850nm: t >= 95% TBDnm: t = 50%

Please email for more details

Alternate switched filter specifications Applicable models: TLXXXx-xxxC

Type	AR coated clear glass
Spectrum	400 – 650nm: t >= 95% 650 – 1050nm: t >= 93.5%

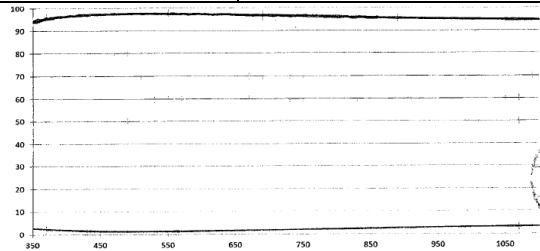

Applicable models: TLXXXx-940x

Type	Long wave pass filter for 940nm illumination
Spectrum	400 nm – 840 nm: T <= 5% 880 +/- 10 nm: T = 50% 900 nm – 980 nm: T >= 95%

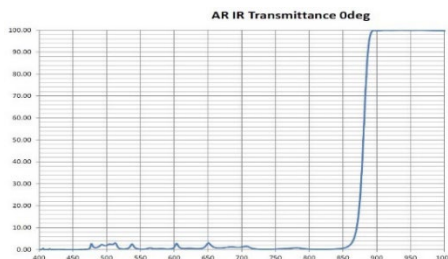

Applicable models: TLXXXx-xxxV

Type	Visible transmission notch filter
Spectrum	405 +/- 10nm: T = 50% 420 – 600nm: T >= 93% ave 650 +/- 10nm: T = 50% 700 – 1000nm: T < 5% max 1000 – 1100nm: T < 10% ave

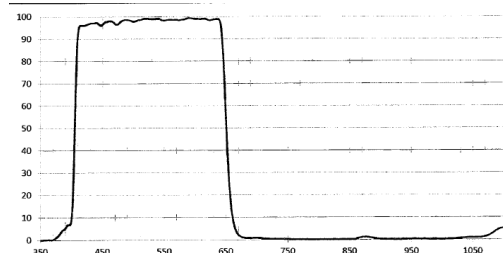

MCR lens motor control board

MCR600, MCR500, MCR400

- ✓ Designed to control Theia motorized lenses.
- ✓ Controls **P-iris, focus and zoom motors, and IR cut motor**
- ✓ Reads photo interrupter limit switches
- ✓ Supports USB, I2C, and LV-TT-UART communications
- ✓ Single 5V supply (via USB or pin connector)
- ✓ Over-current and over-temperature protection
- ✓ Small size

	MCR600 assembly	MCR500 assembly	MCR400 board only
Supported lenses	TL1250P, TL936P, TL410P, ML410P		
Supported lens versions	-R/N4 and -R/N6	-R/N3 and -R/N5	-R/N4 and -R/N6
Iris Support	P-iris only		
Board size (without cables)	65mm x 46mm x 10mm	86mm x 46mm x 14mm	60mm x 25mm x 6mm
Weight	15g		10g
Mounting holes	2x M4 with plastic housing		4x M2
Operating voltage	5V (via USB or pin)		
Operating current (single motor movement)	Approx. 250mA		
Max operating current	Up to 800mA		

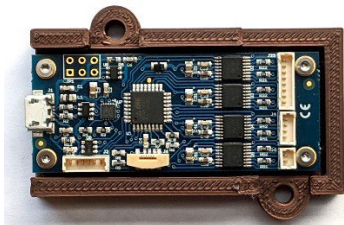

MCR600 with holder

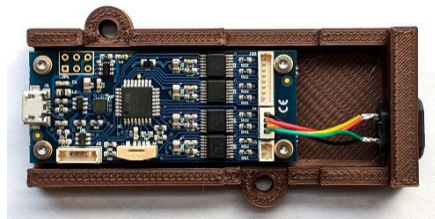

MCR500 with holder



MCR400 board



Company profile

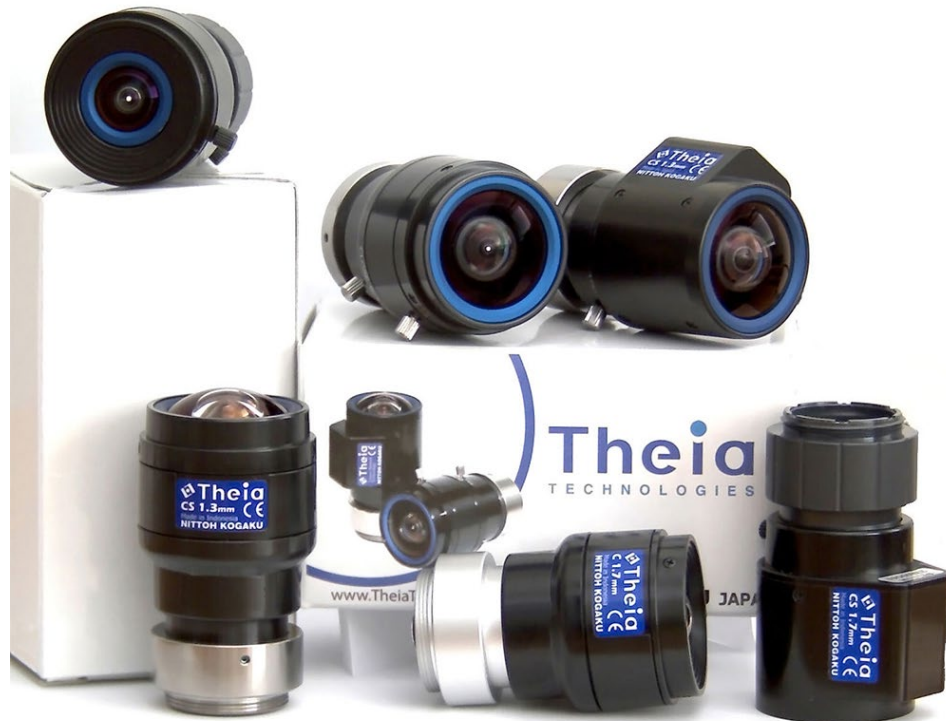

Theia Technologies delivers high-performance precision optics to meet the exacting requirements of machine vision, automation, robotics, intelligent transportation, and other industrial imaging applications. Theia's patented Linear Optical Technology[®] lenses provide an ultra-wide field of view without barrel distortion, correcting distortion optically, without the use of software. Theia's 4k resolution lenses come with manual and motorized options for a variety of image formats and mounts. Theia's compact, multi-megapixel telephoto lenses are selected by companies worldwide for ANPR, LPR and ITS applications to provide high image detail in visible and NIR light. Theia also provides optical engineering and custom design services to meet our clients' specific requirements.

