



UV manufacturer  
SUSTAINABILITY  
LEADERS 23 Years  
Since 2001

**Guangzhou WELGO Environmental Equipment Co.,Ltd**

 Factory 2, No.22, 1st Street, Daban Industrial Zone, Tinggen Village, Shatou Street,  
Panyu District, Guangzhou, China

 +86 13580386804

 sales@uvc.com.cn

 <http://en.uvc.com.cn/>



# WELGO-UV

Guangzhou WELGO Environmental Equipment Co.,Ltd



WELGO is a high-tech enterprise specializing in the manufacture of UV sterilizers and OZONE generators. As one of the leading experts in the industry for decades, WELGO offers a full range of services, including R&D, design, production, and customer service.

Since its establishment in 2001, WELGO has delivered tens of thousands of UV sterilizers and OZONE generators, earning a global reputation for outstanding performance.

With our achievements in technology, management, and resource optimization, WELGO continues to build excellent products and services, always striving for the best.



# CONTENTS

Product composition	01
F Series	03
K Series	11
L Series	19
Accessories	25

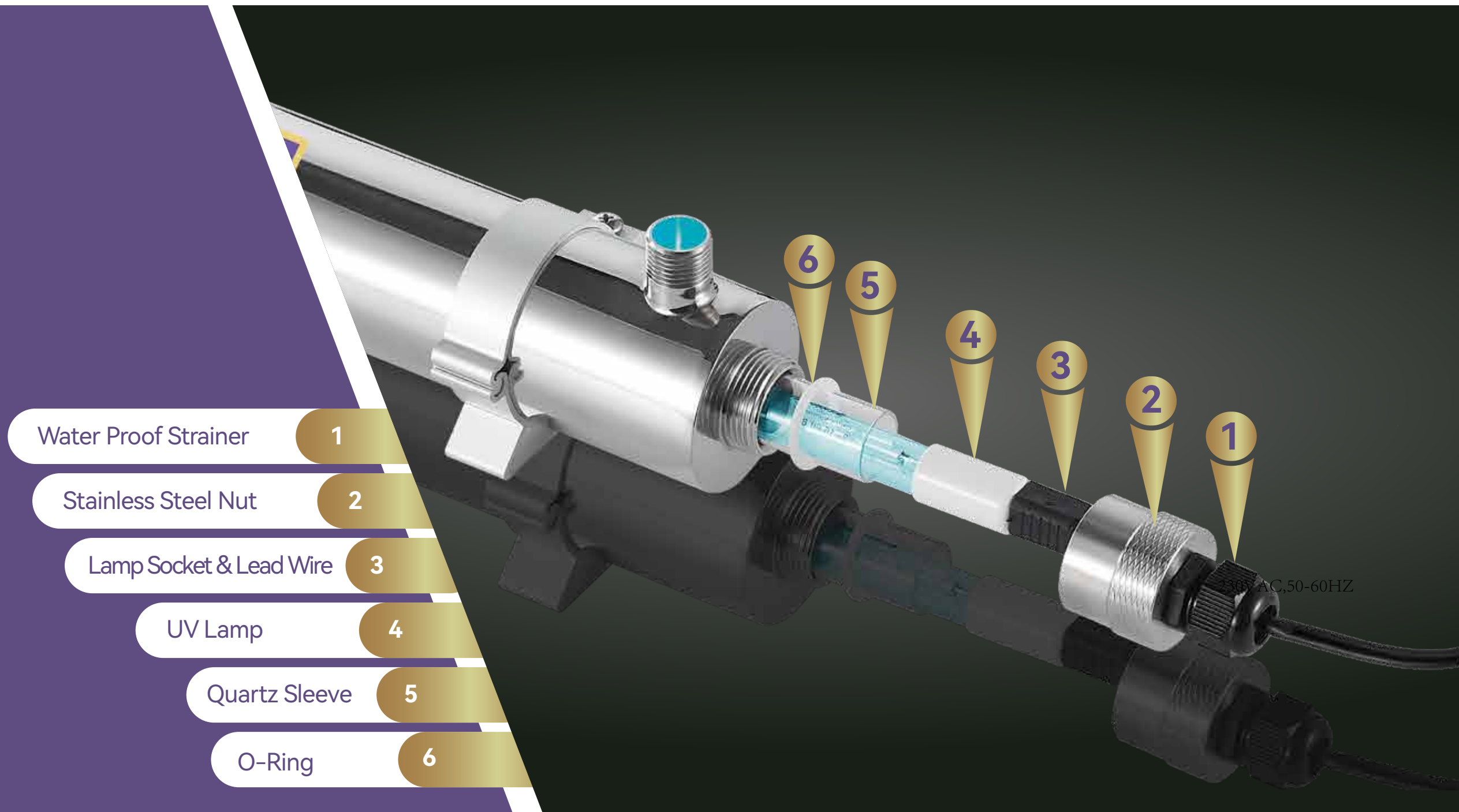

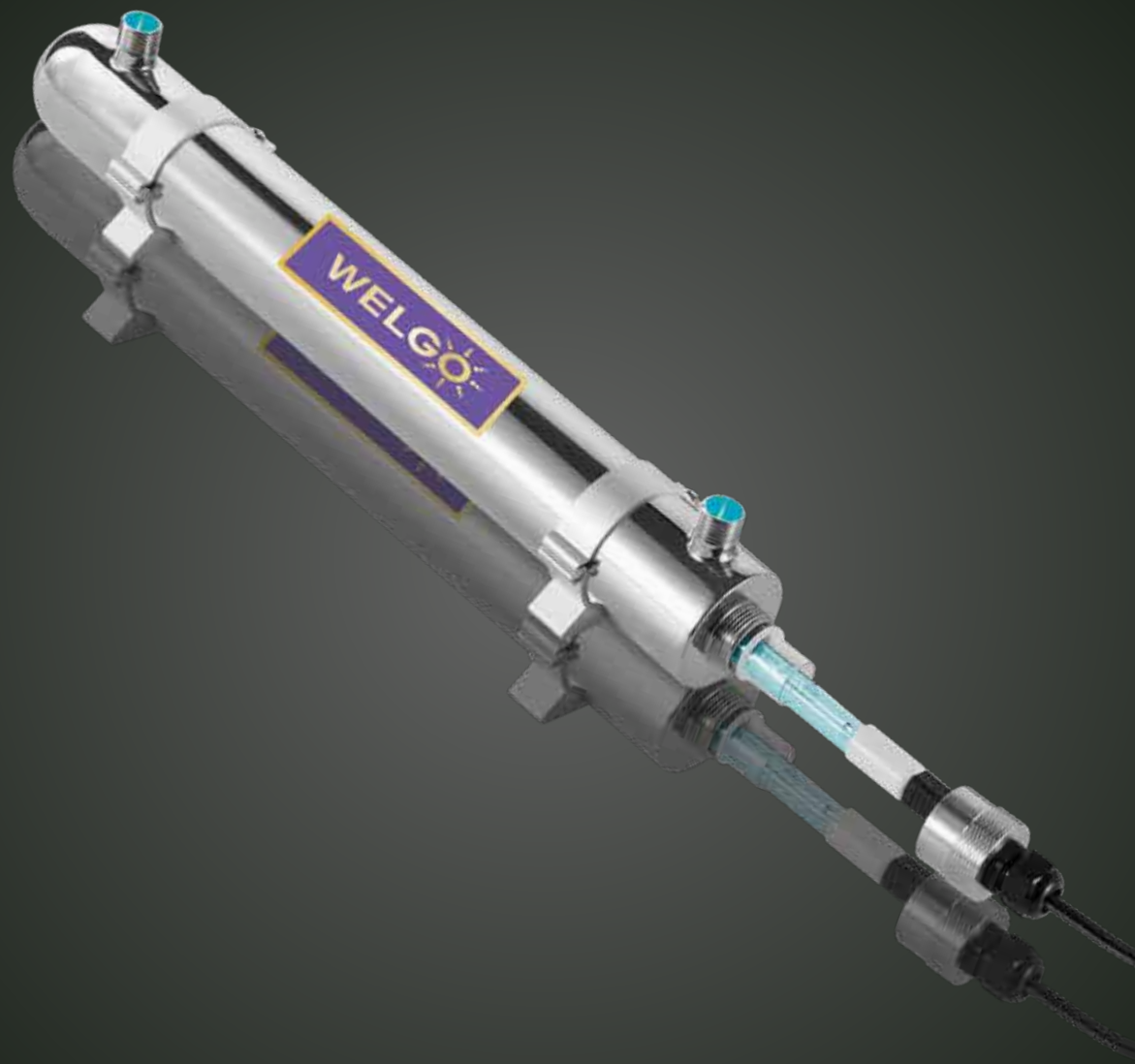

**Model** WGUUV-F01  
CE Certificate

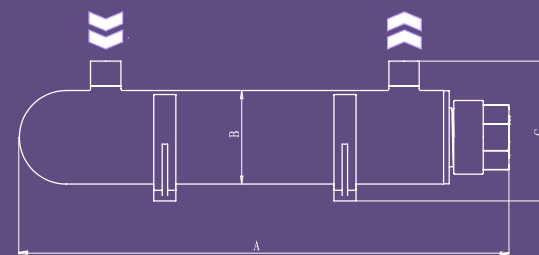

Ultraviolet  
Water Treatment  
System



Model	WGUUV-F01
Inlet/Outlet Size	G1/4" inner thread
A/B/C Size unit:mm	270/51/67
Lamp Model	GPH212T5L/4P
Quartz Sleeve	φ23*245*1.5mm, closed end
Lamp design operation Life	9000-10000Hrs
Volts	230VAC,50-60HZ
Alarm	LED
Chamber Material	SS304/SS316
Operating Pressure	0-0.7MPa
Operating Temperature	5-40°C

Surface treatment option: polishing or sandblasting



**Model** WGUV-F02  
CE Certificate

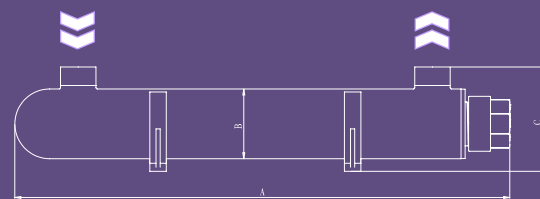

Ultraviolet  
Water Treatment  
System



Model	WGUV-F02
Inlet/Outlet Size	G1/2" outer thread
A/B/C Size unit:mm	354/51/67
Lamp Model	GPH287T5L/4P
Quartz Sleeve	φ23*330*1.5mm, closed end
Lamp design operation Life	9000-10000Hrs
Volts	230VAC,50-60HZ
Alarm	LED
Chamber Material	SS304/SS316
Operating Pressure	0-0.7MPa
Operating Temperature	5-40°C

Surface treatment option: polishing or sandblasting



**Model** WGUV-F06  
CE Certificate

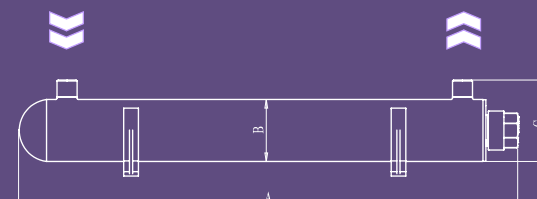

Ultraviolet  
Water Treatment  
System



Model	WGUV-F06
Inlet/Outlet Size	G1/2" outer thread
A/B/C Size unit:mm	510/63/84
Lamp Model	GPH436T5L-4P
Quartz Sleeve	φ23*485*1.5mm, closed end
Lamp design operation Life	9000-10000Hrs
Volts	230VAC,50-60HZ
Alarm	LED
Chamber Material	SS304/SS316
Operating Pressure	0-0.7MPa
Operating Temperature	5-40°C

Surface treatment option: polishing or sandblasting



**Model** WGUUV-F12  
CE Certificate

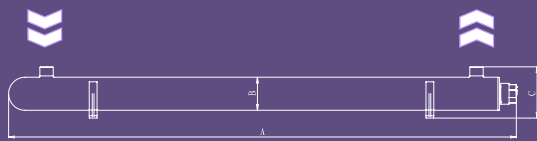

Ultraviolet  
Water Treatment  
System



Model	WGUUV-F12
Inlet/Outlet Size	G3/4" outer thread
A/B/C Size unit:mm	975/63/84
Lamp Model	GPH843T5L/4P
Quartz Sleeve	φ23*950*1.5mm, closed end
Lamp design operation Life	9000-10000Hrs
Volts	230VAC,50-60HZ
Alarm	LED
Chamber Material	SS304/SS316
Operating Pressure	0-0.7MPa
Operating Temperature	5-40°C

Surface treatment option: polishing or sandblasting



**Model** WGUUV-F24  
CE Certificate

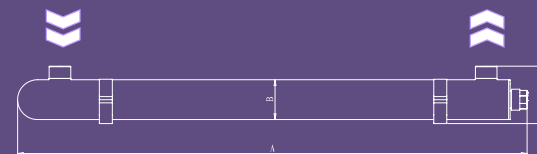

Ultraviolet  
Water Treatment  
System



Model	WGUUV-F24
Inlet/Outlet Size	G 1 1/4" outer thread
A/B/C Size unit:mm	975/76/102
Lamp Model	GHO843T5L/4P
Quartz Sleeve	φ23*950*1.5mm, closed end
Lamp design operation Life	9000-12000Hrs
Volts	230VAC,50-60HZ
Alarm	LED
Chamber Material	SS304/SS316
Operating Pressure	0-0.7MPa
Operating Temperature	5-40°C

Surface treatment option: polishing or sandblasting



**Model** WGUUV-F44  
CE Certificate



Ultraviolet  
Water Treatment  
System



Model	WGUUV-F44
Inlet/Outlet Size	G 1½" outer thread
A/B/C Size unit:mm	1665/76/102
Lamp Model	GHO64T5L/4P
Quartz Sleeve	φ23*1640*1.5mm, closed end
Lamp design operation Life	9000-12000Hrs
Volts	230VAC,50-60HZ
Alarm	LED
Chamber Material	SS304/SS316
Operating Pressure	0-0.7MPa
Operating Temperature	5-40°C



Surface treatment option: polishing or sandblasting





**Model** WGUUV-K01  
CE Certificate

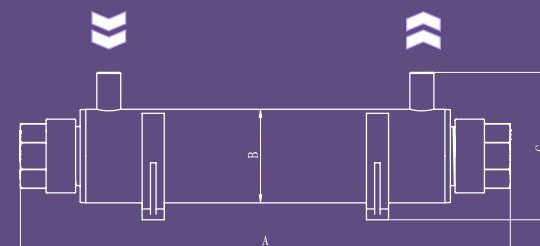

Ultraviolet  
Water Treatment  
System



Model	WGUUV-K01
Inlet/Outlet Size	G1/4" inner thread
A/B/C Size unit:mm	270/51/67
Lamp Model	GPH212T5L/4P
Quartz Sleeve	φ23*245*1.5mm, open end
Lamp design operation Life	9000-10000Hrs
Volts	230VAC,50-60HZ
Alarm	LED
Chamber Material	SS304/SS316
Operating Pressure	0-0.7MPa
Operating Temperature	5-40°C

Surface treatment option: polishing or sandblasting



**Model** WGUV-K02  
CE Certificate

Ultraviolet  
Water Treatment  
System

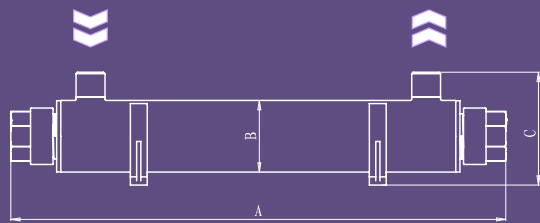

Model	WGUV-K02
Inlet/Outlet Size	G1/2" outer thread
A/B/C Size unit:mm	354/51/67
Lamp Model	GPH287T5L/4P
Quartz Sleeve	φ23*330*1.5mm, open end
Lamp design operation Life	9000-10000Hrs
Volts	230VAC,50-60HZ
Alarm	LED
Chamber Material	SS304/SS316
Operating Pressure	0-0.7MPa
Operating Temperature	5-40°C

Surface treatment option: polishing or sandblasting



**Model** WGUV-K06  
CE Certificate

Ultraviolet  
Water Treatment  
System

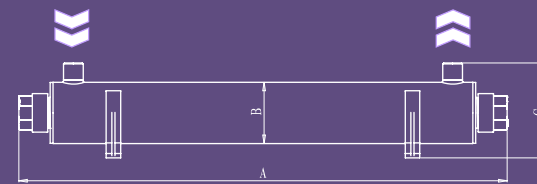

Model	WGUV-K06
Inlet/Outlet Size	G1/2" outer thread
A/B/C Size unit:mm	510/63/88
Lamp Model	GPH436T5L-4P
Quartz Sleeve	φ23*485*1.5mm, open end
Lamp design operation Life	9000-10000Hrs
Volts	230VAC,50-60HZ
Alarm	LED
Chamber Material	SS304/SS316
Operating Pressure	0-0.7MPa
Operating Temperature	5-40°C

Surface treatment option: polishing or sandblasting



**Model** WGUUV-K12  
CE Certificate

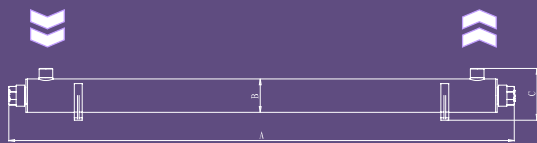

Ultraviolet  
Water Treatment  
System



Model	WGUUV-K12
Inlet/Outlet Size	G3/4" outer thread
A/B/C Size unit:mm	964/63/95
Lamp Model	GPH843T5L/4P
Quartz Sleeve	φ23*950*1.5mm, open end
Lamp design operation Life	9000-10000Hrs
Volts	230VAC,50-60HZ
Alarm	LED
Chamber Material	SS304/SS316
Operating Pressure	0-0.7MPa
Operating Temperature	5-40°C

Surface treatment option: polishing or sandblasting



**Model** WGUUV-K24  
CE Certificate

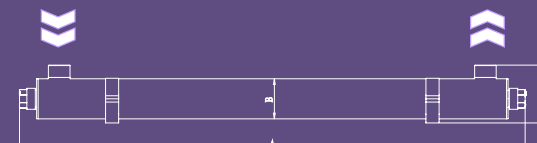

Ultraviolet  
Water Treatment  
System



Model	WGUUV-K24
Inlet/Outlet Size	G 1 1/4" outer thread
A/B/C Size unit:mm	964/76/108
Lamp Model	GHO843T5L/4P
Quartz Sleeve	φ23*950*1.5mm, open end
Lamp design operation Life	9000-12000Hrs
Volts	230VAC,50-60HZ
Alarm	LED
Chamber Material	SS304/SS316
Operating Pressure	0-0.7MPa
Operating Temperature	5-40°C

Surface treatment option: polishing or sandblasting



**Model** WGUV-K44  
CE Certificate

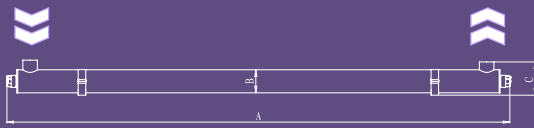

### Ultraviolet Water Treatment System



Model	WGUV-K44
Inlet/Outlet Size	G 1½" outer thread
A/B/C Size unit:mm	1660/76/108
Lamp Model	GHO64T5L/4P
Quartz Sleeve	φ23*1640*1.5mm, open end
Lamp design operation Life	9000-12000Hrs
Volts	230VAC,50-60HZ
Alarm	LED
Chamber Material	SS304/SS316
Operating Pressure	0-0.7MPa
Operating Temperature	5-40°C



Surface treatment option: polishing or sandblasting





**Model** WGUUV-L02  
CE Certificate

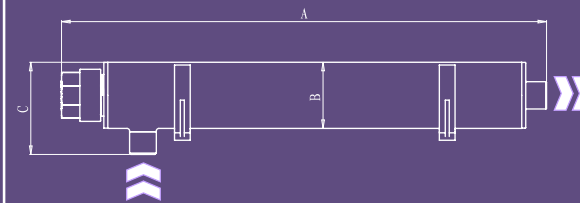

Ultraviolet  
Water Treatment  
System



Model	WGUUV-L02
Inlet/Outlet Size	G1/2" outer thread
A/B/C Size unit:mm	370/51/70
Lamp Model	GPH287T5L/4P
Quartz Sleeve	φ23*330*1.5mm, closed end
Lamp design operation Life	9000-10000Hrs
Volts	230VAC,50-60HZ
Alarm	LED
Chamber Material	SS304/SS316
Operating Pressure	0-0.7MPa
Operating Temperature	5-40°C

Surface treatment option: polishing or sandblasting



**Model** WGUV-L06  
CE Certificate

Ultraviolet  
Water Treatment  
System

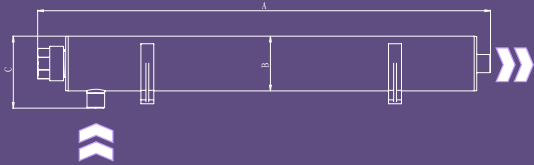

Model	WGUV-L06
Inlet/Outlet Size	G1/2" outer thread
A/B/C Size unit:mm	523/63/84
Lamp Model	GPH436T5L-4P
Quartz Sleeve	φ23*485*1.5mm, closed end
Lamp design operation Life	9000-10000Hrs
Volts	230VAC,50-60HZ
Alarm	LED
Chamber Material	SS304/SS316
Operating Pressure	0-0.7MPa
Operating Temperature	5-40°C

Surface treatment option: polishing or sandblasting



**Model** WGUV-L12  
CE Certificate

Ultraviolet  
Water Treatment  
System

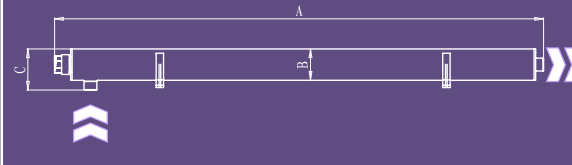

Model	WGUV-L12
Inlet/Outlet Size	G3/4" outer thread
A/B/C Size unit:mm	992/63/90
Lamp Model	GPH843T5L/4P
Quartz Sleeve	φ23*950*1.5mm, closed end
Lamp design operation Life	9000-10000Hrs
Volts	230VAC,50-60HZ
Alarm	LED
Chamber Material	SS304/SS316
Operating Pressure	0-0.7MPa
Operating Temperature	5-40°C

Surface treatment option: polishing or sandblasting



**Model** WGUUV-L24  
CE Certificate

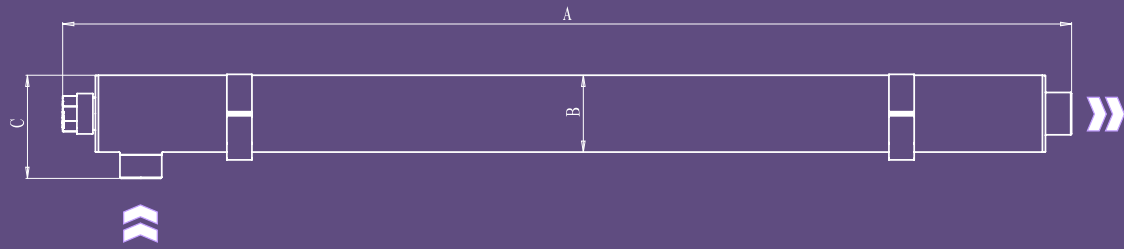

Model	WGUUV-L24
Inlet/Outlet Size	G 1¼" outer thread
A/B/C Size unit:mm	1002/76/102
Lamp Model	GHO843T5L/4P
Quartz Sleeve	φ23*950*1.5mm, closed end
Lamp design operation Life	9000-12000Hrs
Volts	230VAC,50-60HZ
Alarm	LED
Chamber Material	SS304/SS316
Operating Pressure	0-0-0.7MPa
Operating Temperature	5-40°C

### Ultraviolet Water Treatment System



Surface treatment option: polishing or sandblasting



### Ballast

Our 4th generation product is a waterproof ballast with automatic protection function when contacting with water.

This ballast is made of an integrated circuit. It can avoid short circuited caused by water leakage due to improper installation or O-ring aging and cracking.

Once a liquid is detected on the socket or pin of the lamp, the circuit will be cut off.

Some multinational giant companies have asked their factories around the world to have this security feature in their UV system, which can effectively prevent the fire caused by water seepage. At the same time, it can also avoid electric shock when used in the swimming pool and SPA industries.

- LED Alarm
- Instant Start
- Operation indication light

- Energy saving model, high efficiency, no noise
- Simple installation
- Easy for replacement

WGB-425-40



Voltage	220-240V	Wattage	10-40W
Frequency	50/60Hz	Current	0.39-0.43A

WGB-1-155



Voltage	110-240V	Wattage	100-155W
Frequency	50/60Hz	Current	1.0A

- Power Controller
- Password can be set to protect data
- Digital LCD Display
- Alarm setting
- UV Lamp working well closed circuit signal output
- Power supply interruption / UV Lamp abnormal signal output
- Temperature control and ballast protective feature: circuit will be cut off while Quartz sleeve overheat
- Globally applicable
- 100-240V/50-60Hz
- UL,CE Certified

EPS51-425-40L



Voltage	110-240V	Wattage	10-40W
Frequency	50/60Hz	Current	0.35-0.45A

EBS-EA-H00-95L



Voltage	110-240V	Wattage	48-95W
Frequency	50/60Hz	Current	0.75-0.85A

WGB-1-40-BL



Voltage	110-264V	Wattage	14-40W
Frequency	50/60Hz	Current	0.39-0.43A

WGB-1-80-BL



Voltage	110-264V	Wattage	55-95W
Frequency	50/60Hz	Current	0.75-0.85A

**UV Lamps:**

**Low Pressure UV-Lamps (254nm/185nm)**

- Designed operation life: 9,000-10,000Hrs
- HO UV-Lamps (High output)  
Designed operation life: 10,000Hrs
- Amalgam UV Lamps  
Designed operation life: 12,000Hrs



O ring



Stainless steel Nut

Aluminium Nut

Plastic Nut

Aluminium C-clip

Plastic C-clip

**Quartz sleeve**

Quartz sleeve (greater than 92% light transmission)

Two types of Quartz sleeve:

Open end quartz sleeve

Closed end quartz sleeve

Nominal thickness of Quartz sleeve is 1.5mm

