

World leaders in dehumidification.

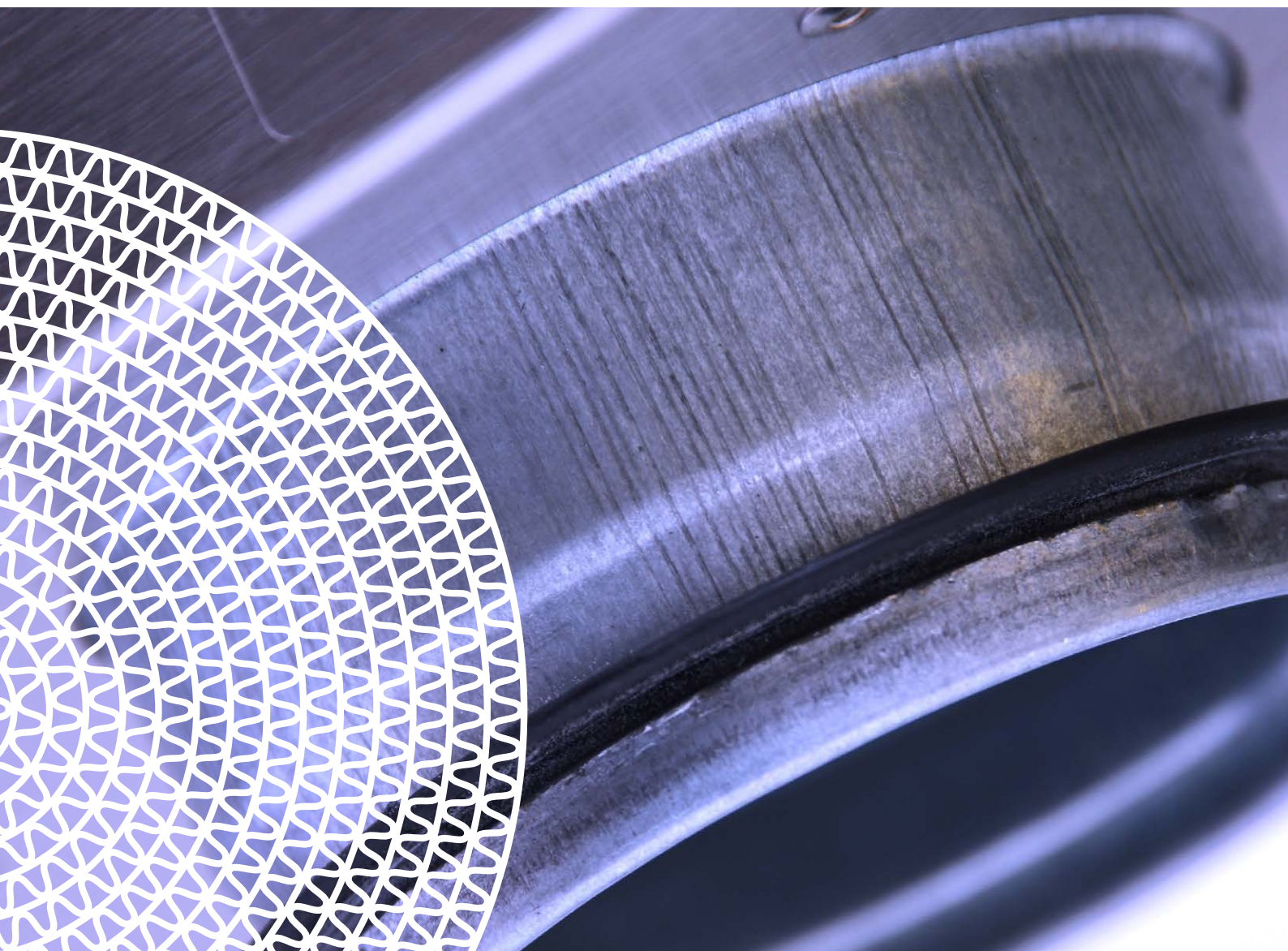

Dehumidifiers – From portable devices to industrial systems

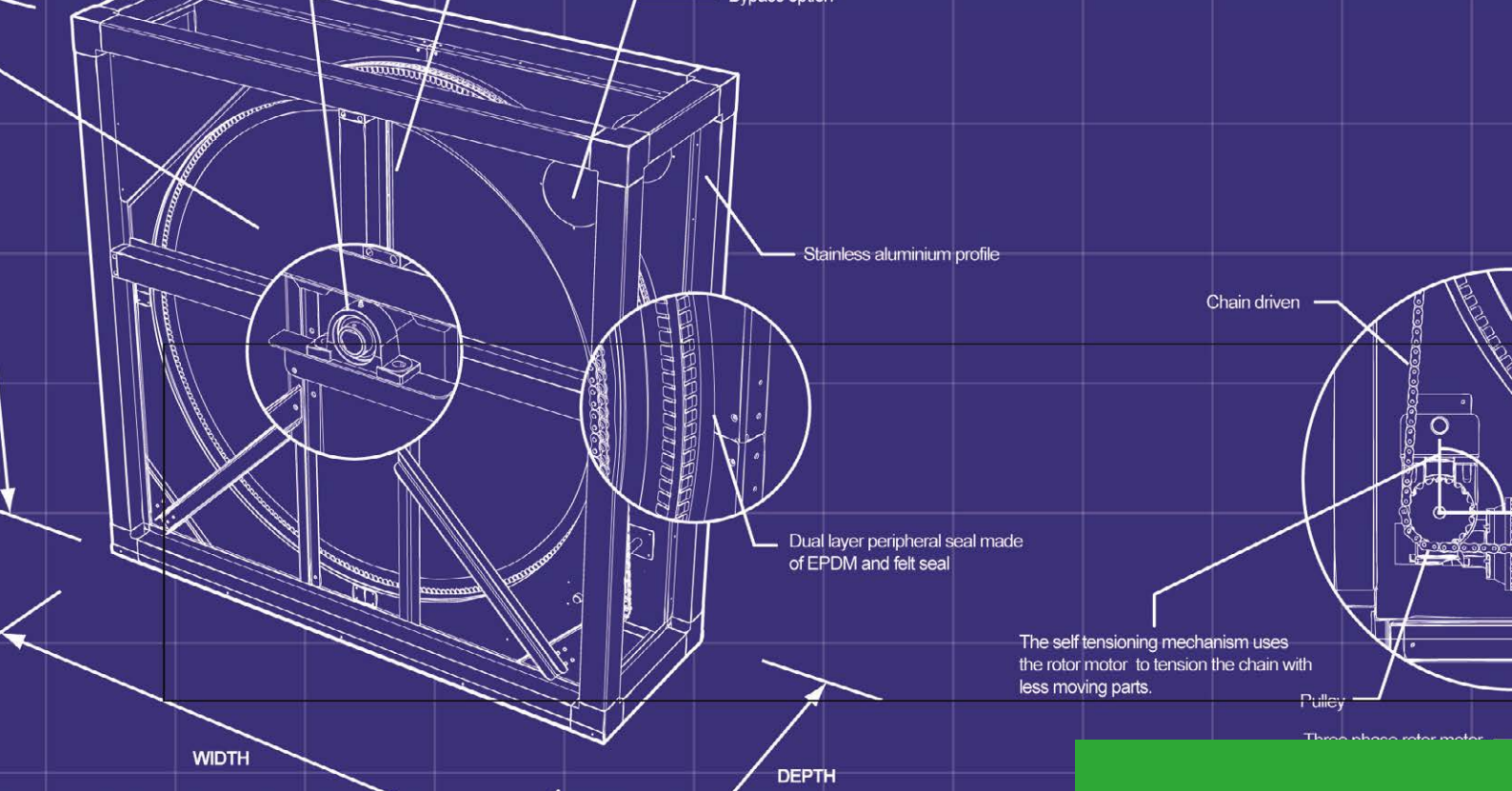



Seibu Giken DST AB
 was established 1985,
 in Sweden

SEIBU GIKEN DST

- DRY AIR SPECIALISTS

Moisture is found everywhere. Air moisture is usually referred to as relative humidity (RH). The "relative" in relative humidity expresses the relation between the amount of water vapour present and the amount that is physically possible at that temperature. In other words, relative humidity expressed as a percentage, is the ratio of the actual partial pressure exerted by water vapour in air to the maximum partial pressure that would be exerted by the water vapour if that air were saturated, at that temperature.

Seibu Giken DST are experts in the field and provide dehumidifiers for all applications. DST dehumidifiers are characterised by their high reliability, low power consumption and service-friendly design. With our help problems that moisture can cause will be avoided.

SILICA GEL ROTOR - THE HEART OF A DST DEHUMIDIFIER

At the heart of every DST dehumidifier there is a D-MAX rotor from Seibu Giken Co. Japan. The first in the world to manufacture silica gel rotors, they remain the world leaders in this technology. The rotor is the most important single component in a desiccant dehumidifier. It is the rotor that determines the capacity, efficiency and lifetime of the dehumidification equipment. After 10 years of operation, the D-MAX rotor still retains more than 90% of its original capacity.

Section of a D-MAX rotor from Seibu Giken Co. Due to the number of flutes in the rotor it adsorbs moisture with high efficiency.

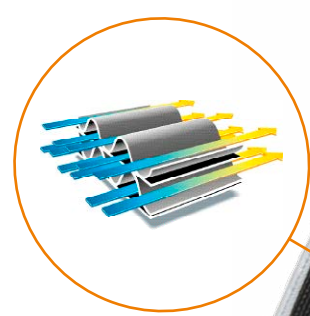

MOISTURE RELATED PROBLEMS

- AND HOW DEHUMIDIFICATION PREVENTS THEM



Condensation

No condensation droplets and subsequent problems with wet products, short circuits in control devices, repainting and puddles on the floor.



Mould

Mould and fungus formation is prevented if the surrounding air is kept below 70%RH.



Corrosion

Extend the lifetime of tools, machines and steel structures by protecting untreated steel against corrosion without painting or greasing.



Bacteria

If the relative humidity is kept below 50%RH bacteria will not thrive.



Frost and ice fouling

No ice fouling on products, floors and ceilings. Also, extended times between defrosting and thereby increased operating time of freezers.





Product sticking

Moisture sensitive products do not stick together and problems with clogged pneumatic transport and lump formation in silos are removed.

SORPTION DEHUMIDIFICATION

- HOW DOES IT WORK?

In sorption dehumidification, the basic principle is that a rotating rotor in the dehumidifier continuously adsorbs moisture from the process air. Then through a regeneration cycle the moisture is driven out of the rotor and exhausted in different ways, the principle pictures are demonstrating how.

-  Incoming moist air
-  Outgoing dry air
-  Outgoing wet air, either passed or condensed out

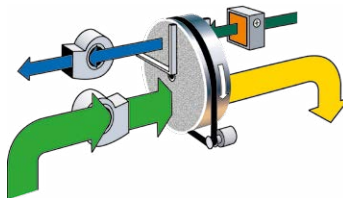

The **Consortb** principle is best used at lower regeneration temperatures, typically where waste heat is available or where the air inlet moisture content is very high. The Consortb principle is also used in balanced 'closed' type systems where the dry process air is recirculated.

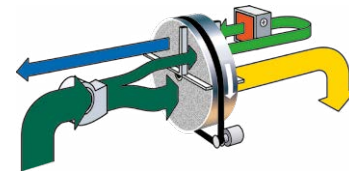

Recusorb DR has an internal heat recovery with one fan that produces both the dry airflow and the wet airflow. Used for introducing dry fresh air into a process or to an 'open' or 'total loss' system where the dehumidified air is ducted into the object. Can be used on both 'open' and 'closed' type systems.

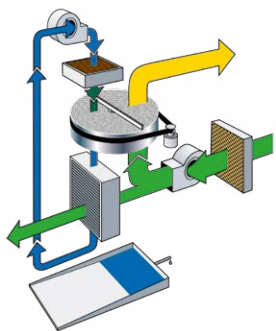

Aquasorb basically functions as a Consortb but moisture in the wet air is condensed through an air cooled condenser. One centrifugal fan is used for both the dry air and the condenser cooling air, so all energy released during the process accumulates in the room. Commonly used where it is impractical to use ducting for the reactivation air system.

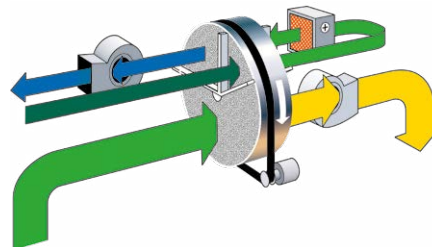

Recusorb R has an internal heat recovery to improve operating efficiency. Heat transferred to the rotor during regeneration is effectively recovered by the incoming regeneration air, thus reducing the amount of energy required by the regeneration heater. The process air outlet is both cooler and drier when compared to other desiccant dryers.

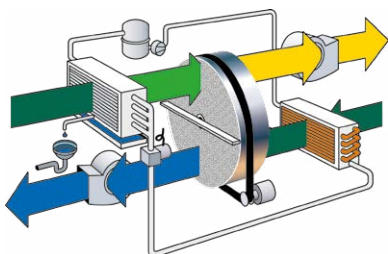

Econosorb combines a heat pump with the sorption rotor in a unique way, providing very low energy consumption with a low dry air temperature. It's probably the most energy efficient dehumidifier on the market, with approximately 25% of the total energy consumption of regular sorption dehumidifiers. Econosorb has both condensation and wet air flow.

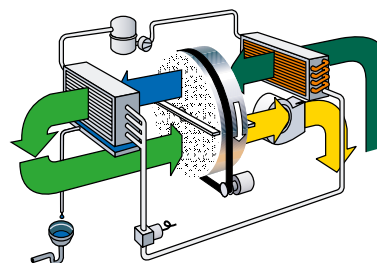

Frigosorb is used in applications where it is difficult to remove a wet air flow. Thanks to the heat pump function Frigosorb is very energy efficient, using approximately 33% of the total energy consumption of regular sorption dehumidifiers.

DST DEHUMIDIFIERS

Consorb CS
CS-5/5L



0.35 0.4
65 90

Consorb
DC-5



0.5
120

Recusorb DR
DR-010B



0.6
190

Consorb
DC-10



0.6
190

Aquasorb
AQ-30B/31B/31L



0.85 1.15 1.55
330 330 370

Recusorb DR
DR-20B/30D



0.8 1.1
330 360

Consorb
DC-20/30 T10, T16



1.1 1.3 1.5
310 400 400

Recusorb DR
DR-31 T10



1.6
310

Recusorb DR
DR-40 T10, T16



1.6 2.3
600 550

Consorb
DC-31 T10, T16



1.4 2.1
300 490

Recusorb DR
DR-50R



2.8
600

Consorb
DC-50R



3.0
550

Recusorb R
RL-60/60LR



4 5
850 1000

Recusorb R
RL-61/61L RL-71/71LR



7.5 8 11 11.5 13 14 17
1300 1600 1800 2100 2500
3000 3200

Recusorb R
RLZ-81/82/101/102/102L/104



19 20 25 27 30.5
34 49.5 57 70 54
2900 3500 4500 4600 6000
7000 9000 10000 10500 12000

Consorb
CZ-82/102/102L/104



22 23 36 39
50 55 65 69
3200 5200 7200 8000
10000 12000



**Consorb, Econosorb,
Frigosorb, Recusorb**

Flexisorb

LARGER





Capacity kg/h
(20°C/60%RH)

Airflow m³/h

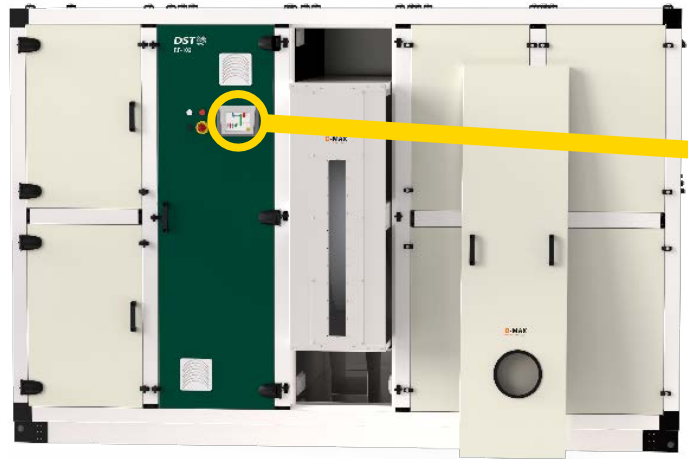
DEHUMIDIFIERS FOR INDUSTRIAL APPLICATIONS

The Flexisorb dehumidifier system can be tailored to suit individual requirements. Everything from basic desiccant dehumidification to a complete climatic control system is offered. With total flexibility in design, these highly efficient industrial atmospheric air dryers are structured around the rotor to conform precisely to customers' specifications. Dehumidification is the prime objective of Flexisorb, and whilst pre-cooling is often required, post cooling and post heating can also be included. The Flexisorb system offers one of the most versatile air drying systems available today.



-  Rotor
-  Heater
-  Cooler
-  Filter
-  Fan

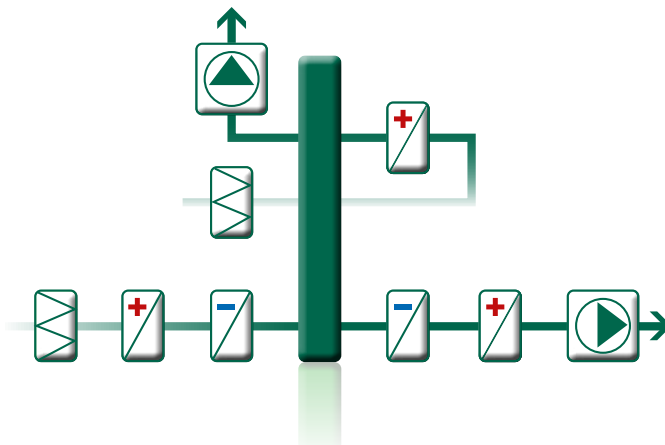

Example of configuration for a Flexisorb

A FLEXISORB'S QUALITIES

All Flexisorb dehumidifiers are designed to be energy-efficient and environmentally friendly. Regeneration heaters are available for use with natural gas, LPG, steam, hot water and electric - or a combination of two. Flexisorb units are constructed with an anodized aluminium frame and a smooth interior that makes it easy to wash to maintain good hygiene levels. Stainless steel panels are available as options for dehumidification in demanding environments.

In the Flexisorb dehumidifiers the Consorb, Econosorb, Frigosorb or Recusorb principles can be used.

HUMIDITY AND TEMPERATURE CONTROL

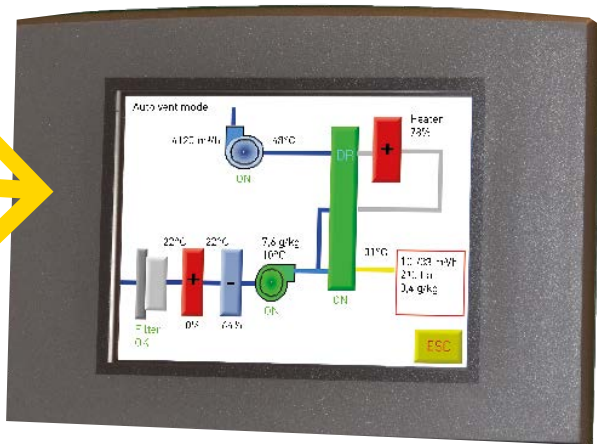

**PLC C4 with 5.7" graphic touch display.
Advanced PLC control with large expansion options**



Humidistat and controller EH3 T2



Humidistat EH4

DST can deliver dehumidifiers with complete control systems for both humidity and temperature control. By having integrated control of the output temperature, the total energy consumption is reduced in the air handling process. This is due in part to the optimized controls that regulate the dehumidification process and temperature requirements and in part by setting the right configuration and using fresh air and exhaust air to suit each case. PLC C4 is used for advanced control of our larger dehumidifiers. The features are tailored to fit the customers' requirements and can be set to communicate with higher-level systems with Modbus. There is also an option to mirror the PLC's control panel to an external computer via the supplied software. This makes it easy to set the controller values and load operational data remotely and therefore provides a cost-effective control of the process.

Additional control options for all DST dehumidifiers are the EH3 and EH4 controllers. The EH3 T2 humidity controller can control linearly or on/off with the parameters relative humidity, absolute humidity, dew point and temperature, as well as optional communication to a superior system via Modbus. It can also be programmed to keep a surface condensation free with the addition of our surface temperature sensor. For a simple control experience, the EH4 humidistat controller can control the dehumidifier via an RH set-point in one or two steps making this an ideal humidistat for dehumidification only applications.

COMMUNICATION AND MONITORING

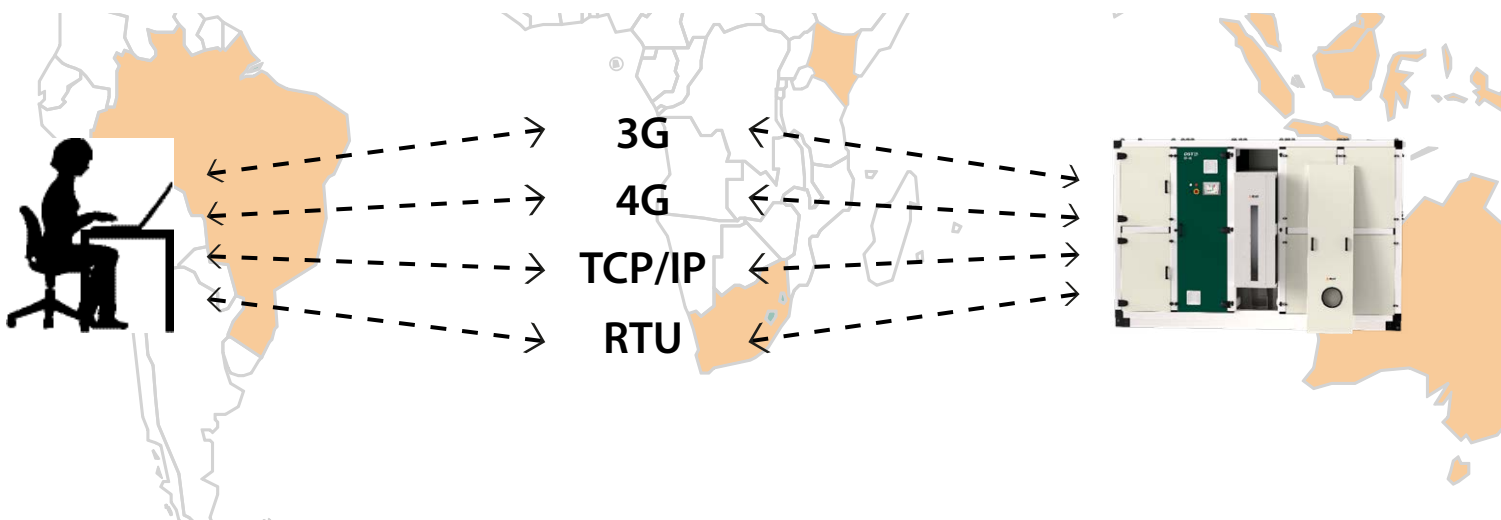

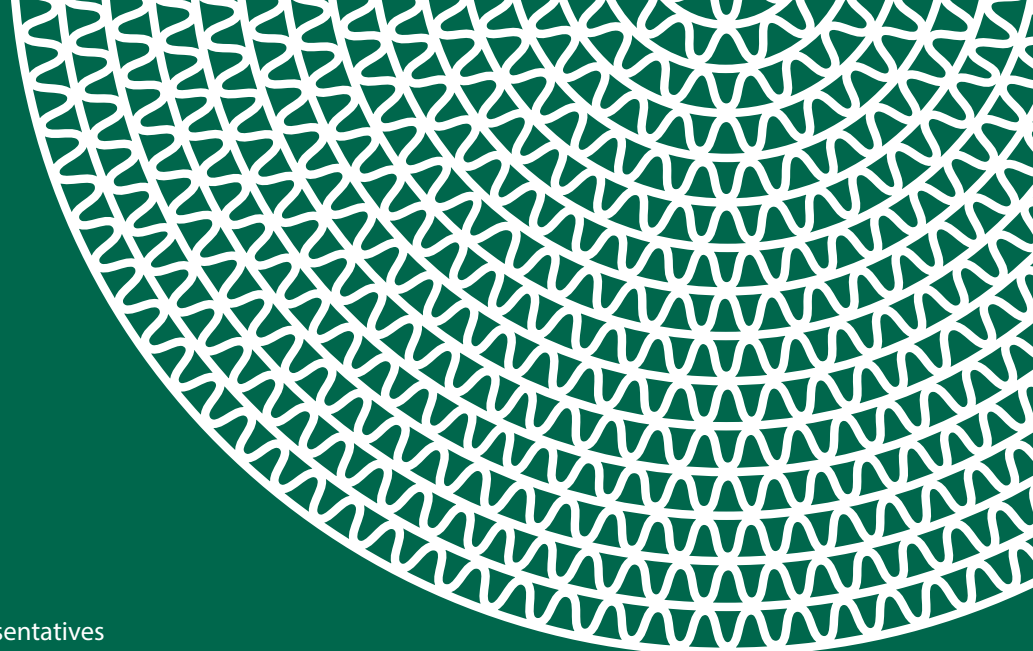

Seibu Giken DST AB has representatives
in more than 50 countries worldwide.

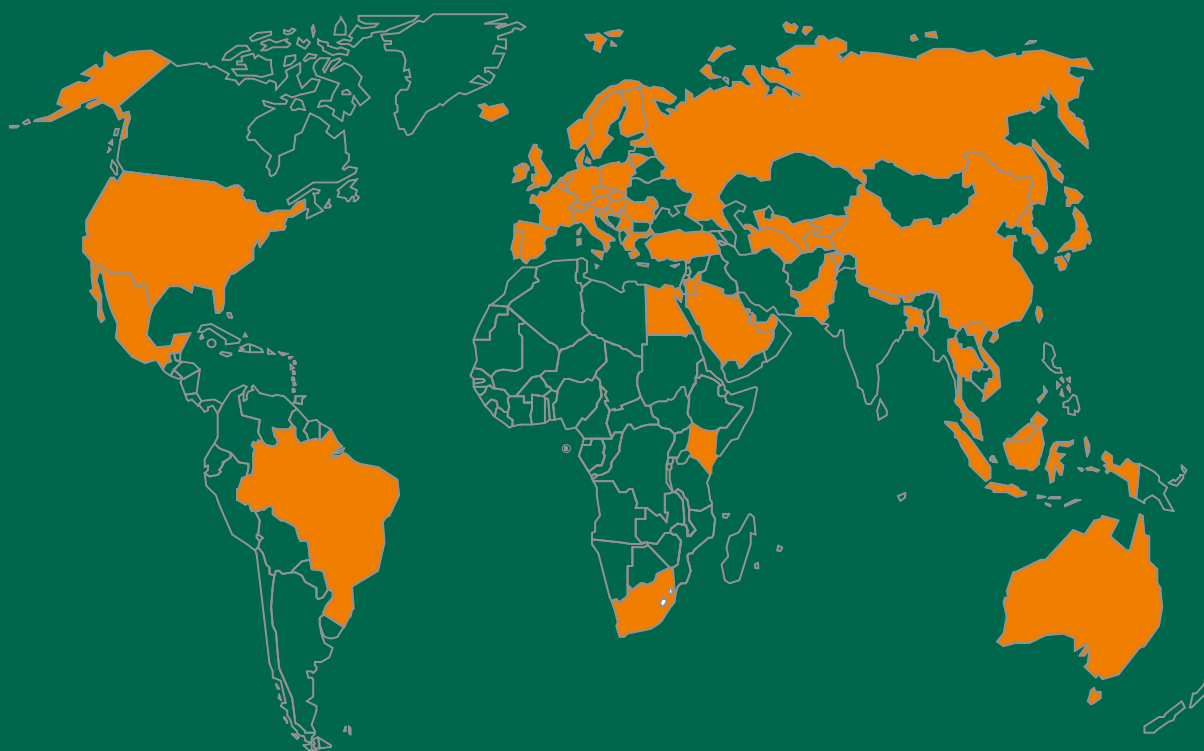

Seibu Giken DST AB
Avestagatan 33 | 163 53 Spånga, Sweden

Phone: +46 8 445 77 20 | Fax: +46 8 445 77 39
info@dst-sg.com | www.dst-sg.com

Seibu Giken DST is certified
according to ISO 9001

Updated 20.06