



# Better Water, Better Life! Sparkling Water Cooler



**Home**  
**Office**  
**HoReCa**



Ningbo Qiangxin Intelligent Technology Co., Ltd. is a high-tech enterprise specializing in the development and manufacturing of high-end sparkling water dispensers for home, office, and Horeca (Hotel, Restaurant, and Café) use. Our core management and technical teams bring over 15 years of industry experience, ensuring expertise and innovation in our product offerings.

Equipped with state-of-the-art production facilities and a rigorous quality management system, we are dedicated to serving the global market. Our products are certified by internationally recognized standards, including UL, NSF, CE, and CB, affirming our commitment to quality and safety.

Renowned for our industry reputation, we not only offer a diverse product range but also provide customized solutions tailored to meet our customers' unique requirements.

# Sparkling Water Cooler Catelogue



Home

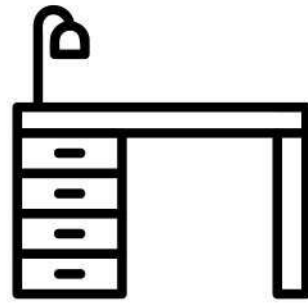

Office



# Sparkling Water Cooler

Tabletop FST06A

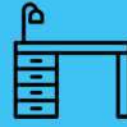

COLD



SPARKLING



AMBIENT

FST06A-CSA

Or



COLD



SPARKLING



HOT

FST06A-CSH

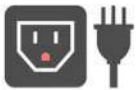

110-120V



220-240V

## Standard Features

- \* Various water options
- \* Touch button control
- \* Safety lock for hot water
- \* R600a or R134a refrigerant

Model No.: FST06A

Compressor Power: 1/8 HP

Sparkling Tank Volume: 3 L

Hot Tank Volume: 0.8 L

Cooling Capacity: 6.0 L/h    Cooling power: 100W

Heating Capacity: 5.0L/h    Heating Power: 500W

Hot Water Temperature: 90-93 Degree Centigrade

Cold Water Temperature: 4-10 Degree Centigrade

Machine Size: D36\*W24\*H42cm

Packing Dimension: L46\*W28.5\*H47cm

NW: 15kg

GW: 16.5kg

20FT: 400pcs;

40FT: 840pcs



# Sparkling Water Dispenser

Under Sink FCD06A

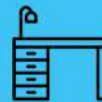

10L/h

## Compressor Cooling System



COLD



SPARKLING



AMBIENT



HOT

FCD06A-CSAH



COLD



AMBIENT

Or

FCD06A-CA



Type A



Type B



110-120V



220-240V

Under sink sparkling water dispenser, provide sparkling, cold, ambient, hot water options;  
Can be fitted for electrical and mechanical taps  
Compressor cooling system with R134a or R600a refrigerant

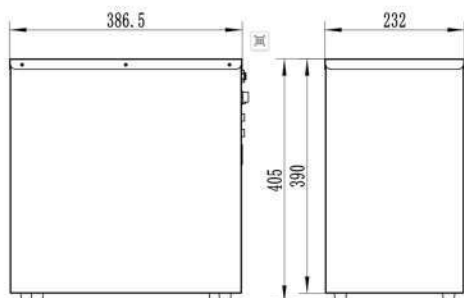

Model No.: FCD06A-CSAH

Compressor Power: 1/6 HP

Cooling Capacity: 10 L/h Heating Capacity: 5L/H

Sparkling Water Tank Volume: 3L

Hot Water Tank Volume: 1L

Cold Water Temperature: 4-10 Degree Centigrade

Product Size: D39\*W23.5\*H40.5

Packing Dimension: L46\*W28\*H50cm

NW: 16kg

GW: 18kg

20FT: 384pcs

40FT/40HQ: 768/960pcs



# Sparkling Water Dispenser

Under Sink FCD12A



## 20L/h

## Compressor Cooling System

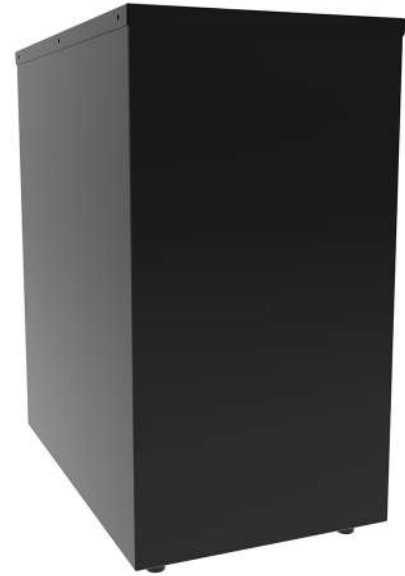

COLD



SPARKLING



AMBIENT

FCD12A-CSA



COLD



AMBIENT

Or

FCD12A-CA



110-120V



220-240V



Type A



Type B

Under sink sparkling water dispenser, provide ambient, cold, sparkling  
Can be fitted for electrical and mechanical taps  
Compressor cooling system with R134a or R600a refrigerant

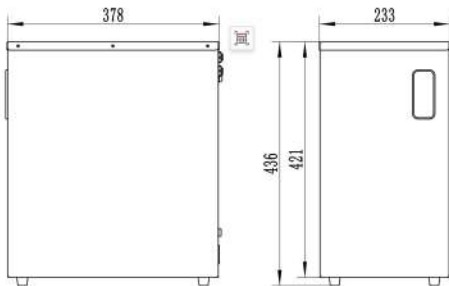

Model No.: FCD12A

Compressor Power: 1/6 HP

Cooling Capacity: 20 L/h

Cold Water Tank Volume: 3.6 L

Sparkling Water Tank Volume: 1.3 L

Cold Water Temperature: 4-10 Degree Centigrade



Product Size: D38\*W23.5\*H43.5

Packing Dimension: L46\*W28\*H50cm

NW: 16kg

GW: 18kg

20FT: 384pcs

40FT/40HQ: 768/960pcs

# Sparkling Water Dispenser

Under Sink FCD12C



## 20L/h

## Compressor Cooling System



COLD



SPARKLING



AMBIENT

FCD12C-CSA



Or

COLD



AMBIENT

FCD12C-CA



110-120V



220-240V



Type A



Type B

With temperature display and adjust function

Can be fittable for electrical and mechanical taps

Under sink sparkling water dispenser, provide ambient, cold, sparkling

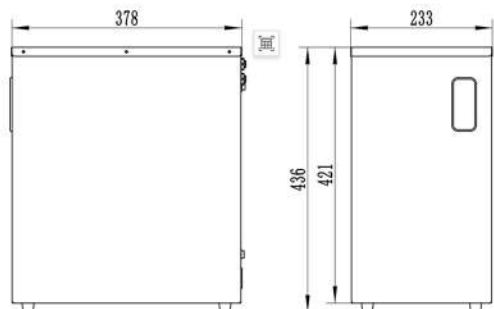

Model No.: FCD12C

Compressor Power: 1/6 HP

Cooling Capacity: 20 L/h

Cold Water Tank Volume: 3.6 L

Sparkling Water Tank Volume: 1.3 L

Cold Water Temperature: 4-10 Degree Centigrade



Product Size: D38\*W23.5\*H43.5

Packing Dimension: L46\*W28\*H50cm

NW: 16kg

GW: 18kg

20FT: 384pcs

40FT/40HQ: 768/960pcs

# Sparkling Water Cooler

Tabletop FYT02A

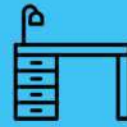

COLD



HOT

FYT02A-CH

Or



COLD



AMBIENT

FYT02A-CA



COLD



SPARKLING



HOT

FYT02A-CSH



Pushing to get water



110-120V



220-240V

Touch-sensitive switch for both heating and cooling system



## Standard Features

- \*With internal filter
- \*Stainless steel hot and cold tank
- \*Safety lock for hot water
- \*R600a or R134a refrigerant

Model No.: FYT02A-CSH

Compressor Power: 1/8 HP

Hot Tank Volume: 1.2 L

Hot Water Capacity: 5L/H

Cold Tank Volume: 3.0L

Cold water capacity: 6L/H

Sparkling Water Tank Volume: 1.0 L

Sparkling Water Capacity: 5L/H

Hot Water Temperature: 90 °C

Cold Water Temperature: 4-10 °C

Cooling Power: 100W

Heating Power: 500W

Machine Size: 22\*52\*50cm

Packing Dimension: D56\*W28\*H55.5cm

NW: 19KG

GW: 20.5KG

20FT: 320pcs,

40FT: 672pcs

# Sparkling Water Dispenser

Free Standing FYS02A

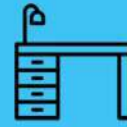

COLD



HOT

FYS02A-CH

Or



COLD



AMBIENT

FYS02A-CA



COLD



SPARKLING



HOT

FYS02A-CSH



110-120V



220-240V



With Sparkling, Cold, Hot water options

Touch-sensitive switch for heating and cooling system

## Standard Features

- \*With UF or RO internal filter, could hold CO2 cylinder inside
- \*Stainless steel hot and cold tank
- \*Safety lock for hot water
- \*R600a or R134a refrigerant

Model No.: FYS02A-CSH

Compressor Power: 1/8 HP

Hot Tank Volume: 2.0 L      Hot Water Capacity: 5L/H

Cold Tank Volume: 3.0 L      Cold Water Capacity: 6L/H

Sparkling Water Tank Volume: 1.0 L      Sparkling Water Capacity: 5L/H

Hot Water Temperature: 90 Degree Centigrade

Cold Water Temperature: 4-10 Degree Centigrade

Machine Size: 26\*48\*116cm

Packing Dimension: L54.5\*W32\*H121cm

NW: 25.5kg      GW: 28kg

20FT: 72pcs, 40FT: 144pcs, 40HQ:288pcs



# Sparkling Water Cooler Catalogue



# Sparkling Water Cooler

Tabletop BST30A

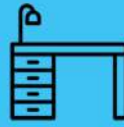

**30 L/h**

**Ice Bank Cooling System**



110-120V



COLD



SPARKLING

BST30A-CS



220-240V

Or



COLD



AMBIENT

BST30A-CA

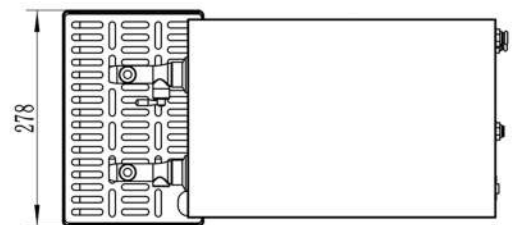
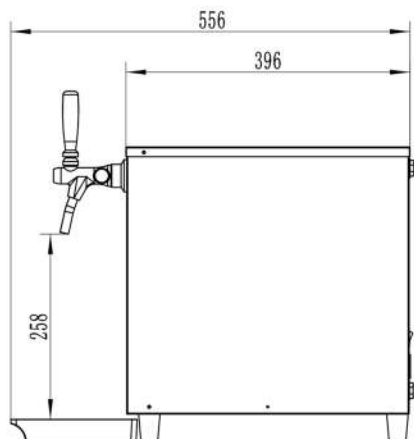
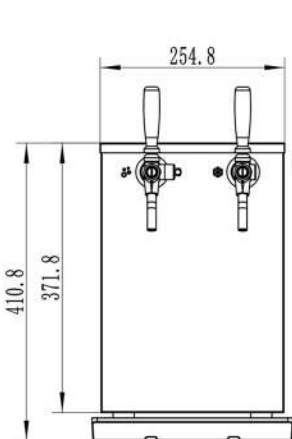

Note: The measurement is mm

## Standard Features

- \* Cold still and sparkling water  
Or ambient and cold still water
- \* Stainless steel finish
- \* R290 or R134a refrigerant

Model No.: BST30A

Compressor Power: 1/6 HP

Ice Bank Tank Volume: 10 L

Sparkling Water Tank Volume: 1 L

Cooling Capacity: 30 L/h

Cold Water Temperature: 4-12 Degree Centigrade

Machine Size: D40\*W25.5\*H41cm

Packing Dimension: L50\*W30\*H50cm

NW: 21kg

GW: 23kg

20FT: 308pcs

40FT: 672pcs;



# Sparkling Water Cooler

Tabletop BST30B

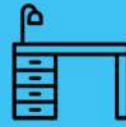

**30 L/h**

**Ice Bank Cooling System**



110-120V



COLD



SPARKLING

BST30B-CS



220-240V

Or



COLD



AMBIENT

BST30B-CA

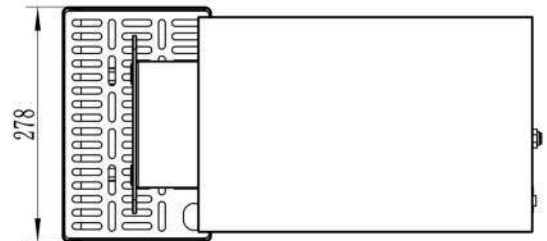
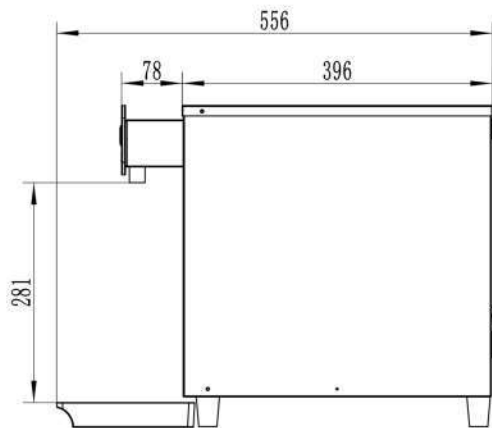
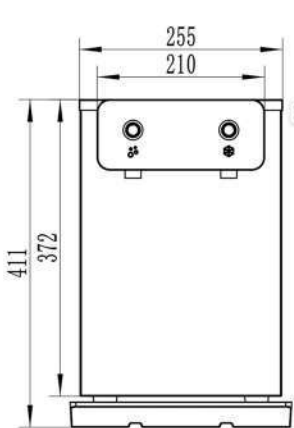

Note: The measurement is mm

## Standard Features

- \* Efficient push button
- \* Cold still and sparkling water  
Or ambient and cold still water
- \* Stainless steel finish
- \* R290 or R134a refrigerant

Model No.: BST30B

Compressor Power: 1/6 HP

Ice Bank Tank Volume: 10 L

Sparkling Water Tank Volume: 1 L

Cooling Capacity: 30 L/h

Cold Water Temperature: 4-12 Degree Centigrade

Machine Size: D47.5\*W25.5\*H41cm

Packing Dimension: L50\*W30\*H50cm

NW: 21kg

GW: 23kg

20FT: 308pcs,

40FT: 672pcs;



# Sparkling Water Cooler

Tabletop BST30C

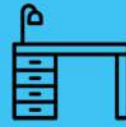

**30 L/h**

**Ice Bank Cooling System**

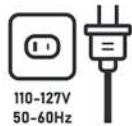

110-127V  
50-60Hz



COLD



SPARKLING

BST30C-CS



220-240V  
50/60Hz

Or



COLD



AMBIENT

BST30C-CA

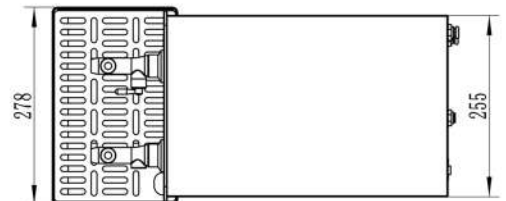
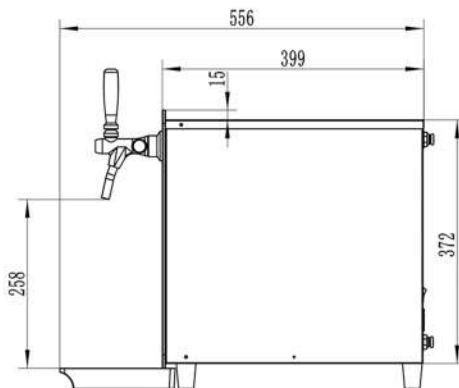
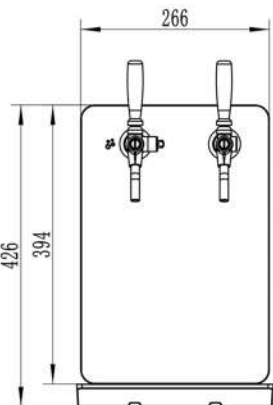

Note: The measurement is mm

## Standard Features

- \* Glass front panel
- \* Cold still and sparkling water  
Or ambient and cold still water
- \* Stainless steel finish
- \* R290 or R134a refrigerant

Model No.: BST30C

Compressor Power: 1/6 HP

Ice Bank Tank Volume: 10 L

Sparkling Water Tank Volume: 1 L

Cooling Capacity: 30 L/h

Cold Water Temperature: 4-12 Degree Centigrade

Machine Size: D40\*W26.6\*H42.6cm

Packing Dimension: L50\*W30\*H50cm

NW: 22kg GW: 24kg

20FT: 308pcs, 40FT: 672pcs;

# Sparkling Water Cooler

Tabletop BST60A

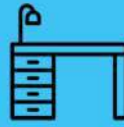

## 60 L/h

## Ice Bank Cooling System



110-120V



COLD



SPARKLING

BST60A-CS



220-240V

Or



COLD



AMBIENT

BST60A-CA

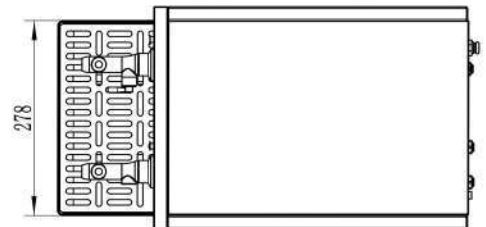
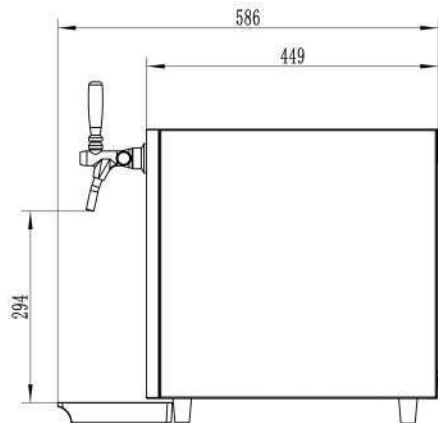
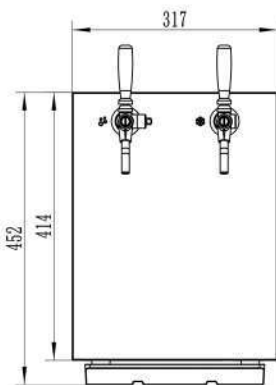

Note: The measurement is mm

## Standard Features

- \*Stainless steel housing
- \*Cold still and sparkling water  
Or ambient and cold still water
- \*R290 or R134a refrigerant

Model No.: BST60A

Compressor Power: 1/6 HP

Ice Bank Tank Volume: 12 L

Sparkling Water Tank Volume: 1.8 L

Cooling Capacity: 60 L/h

Cold Water Temperature: 4-12 Degree Centigrade

Machine Size: D45\*W32\*H45.5cm

Packing Dimension: L64\*W37\*H58cm

NW: 29kg

GW: 31.5kg

20FT: 216pcs

40FT: 432pcs



# Sparkling Water Cooler

Tabletop BST60B

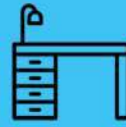

60 L/h

Ice Bank Cooling System



110-120V



COLD



SPARKLING

BST60B-CS



220-240V

Or



COLD



AMBIENT

BST60B-CA

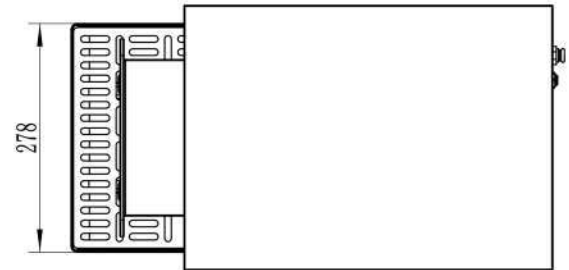
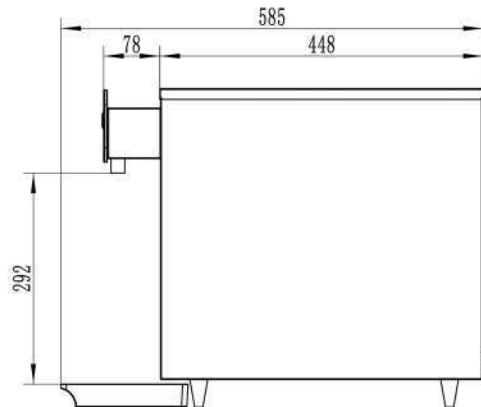
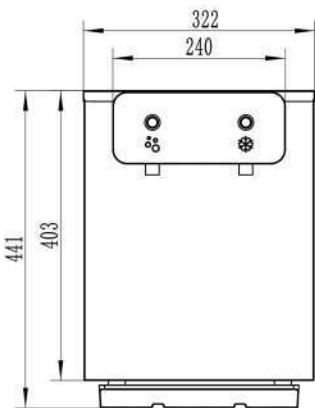

Note: The measurement is mm

## Standard Features

- \*Single-dispense volume adjustable
- \* More efficient push button
- \*Cold still and sparkling water  
Or ambient and cold still water
- \*Stainless steel finish
- \*R290 or R134a refrigerant

Model No.: BST60B

Compressor Power: 1/6 HP

Ice Bank Tank Volume: 12 L

Sparkling Water Tank Volume: 1.8 L

Cooling Capacity: 60 L/h

Cold Water Temperature: 4-12 Degree Centigrade

Product Size: D53\*W32\*H44cm

Packing Dimension: D64\*W37\*H58cm

NW: 29kg      GW: 31.5kg

20GP: 216 sets      40GP: 432 sets



# Sparkling Water Cooler

Tabletop BST60C

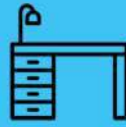

## 60 L/h

## Ice Bank Cooling System



110-120V



220-240V



COLD



SPARKLING

BST60C-CS



COLD



AMBIENT

BST60C-CA

Or

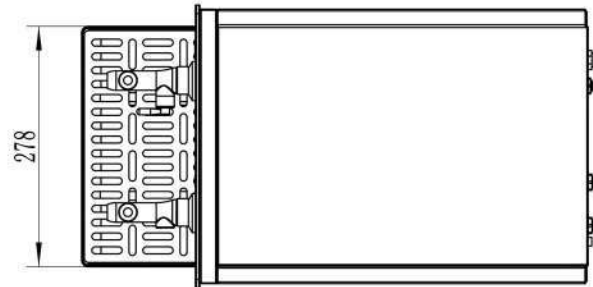
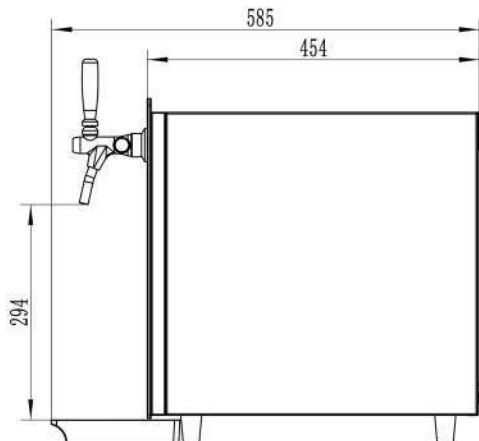
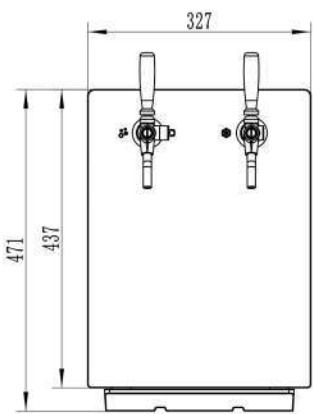

Note: The measurement is mm

## Standard Features

- \*Stainless steel main body
- \* Glass front panel, easy to maintenance
- \*Cold still and sparkling water  
Or ambient and cold still water
- \*R290 or R134a refrigerant

Model No.: BST60C

Compressor Power: 1/6 HP

Ice Bank Tank Volume: 12 L

Sparkling Water Tank Volume: 1.8 L

Cooling Capacity: 60 L/h

Cold Water Temperature: 4-12 Degree Centigrade

Machine Size: D45\*W33\*H47cm

Packing Dimension: L64\*W37\*H58cm

NW: 31kg      GW: 33kg

20FT: 216pcs, 40FT/40HQ: 432pcs;

# Sparkling Water Cooler

Under Counter BSD60A

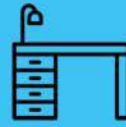

60L/h

Ice Bank Cooling System



COLD



SPARKLING

BSD60A-CS

Or



COLD



AMBIENT

BSD60A-CA

Optional



110-120V



220-240V

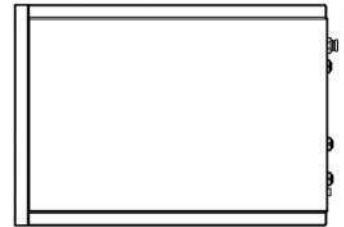
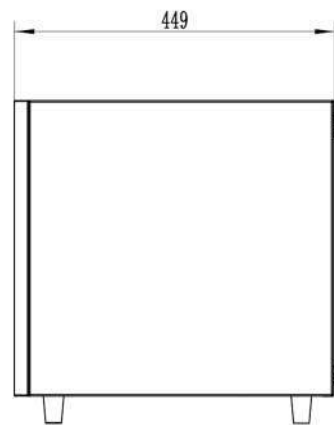
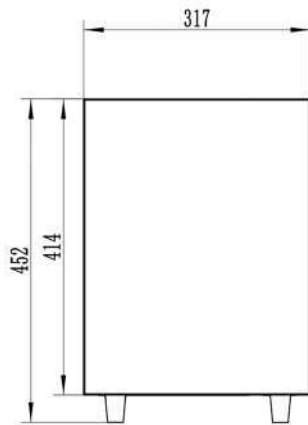

Note: The measurement is mm

## Standard Features

- \* Cold still and sparkling water  
Or ambient and cold still water
- \* Iron sheet with color painting
- \* R290 or R134a refrigerant

Model No.: BSD60A

Compressor Power: 1/6 HP

Ice Bank Tank Volume: 12 L

Sparkling Water Tank Volume: 1.8 L

Cooling Capacity: 60 L/h

Cold Water Temperature: 4-12 Degree Centigrade

Product Size: D45\*W32\*H45cm

Packing Dimension: L64\*W37\*H58cm

NW: 30.5kg GW: 32kg

20FT: 216pcs, 40FT/40HQ: 432pcs



# Sparkling Water Cooler

Tabletop BST90A

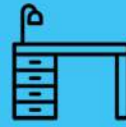

90 L/h

Ice Bank Cooling System



110-120V



220-240V



COLD



SPARKLING



AMBIENT

BST90A-CSA

Or



COLD



COLD



AMBIENT

BST90A-CCA

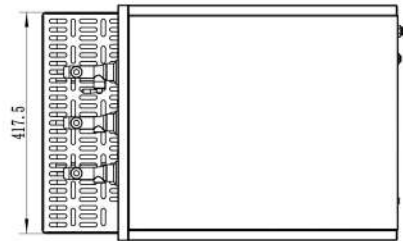
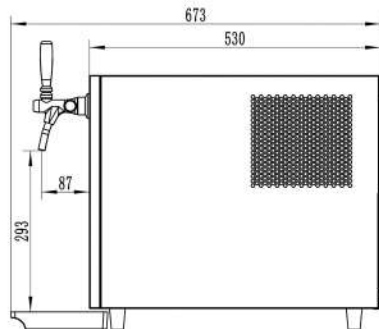
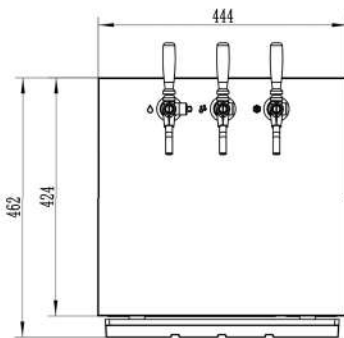

Note: The measurement is mm

## Standard Features

- \* Cold still & sparkling & Ambient  
Or ambient and cold still water
- \* Stainless steel color
- \* R290 or R134a refrigerant

Model No.: BST90A

Compressor Power: 1/4 HP

Ice Bank Tank Volume: 18 L

Sparkling Water Tank Volume: 1.8 L

Cooling Capacity: 90 L/h

Cold Water Temperature: 4-12 Degree Centigrade

Product Size: D53\*W44.5\*H46.5CM

Packing Dimension: L63\*W50\*H56CM

NW:36KG

GW: 39KG

20FT: 144pcs

40FT/40HQ: 288pcs



# Sparkling Water Cooler

Tabletop BST90B

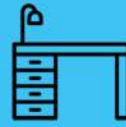

90 L/h

Ice Bank Cooling System



110-120V



220-240V

Or



COLD



SPARKLING



AMBIENT

BST90B-CSA



COLD



COLD



AMBIENT

BST90B-CCA

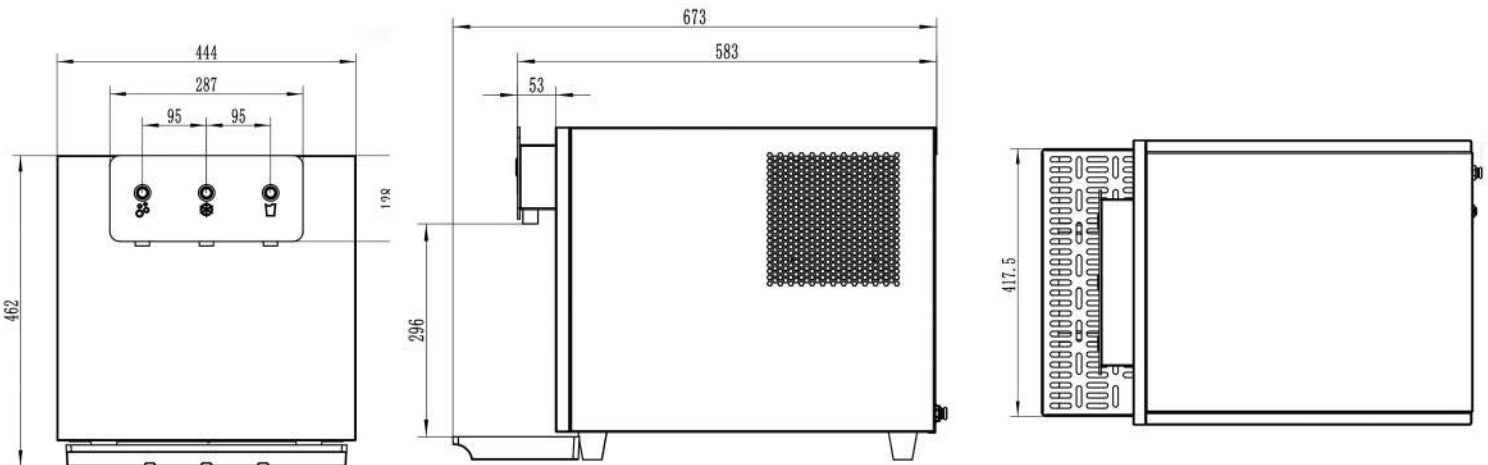

Note: The measurement is mm

## Standard Features

- \* Single discharge volume can be configured based on the discharge time
- \* Cold&sparkling&Ambient
- \* Stainless steel color
- \* R290 or R134a refrigerant

Model No.: BST90B

Compressor Power: 1/4 HP

Ice Bank Tank Volume: 18 L

Sparkling Water Tank Volume: 1.8 L

Cooling Capacity: 90 L/h

Cold Water Temperature: 4-12 Degree Centigrade

Product Size: D58.5\*W44.5\*H46CM

Packing Dimension: D63\*W48\*H58CM

NW: 36kg

GW: 39kg

20GP: 144 SETS

40GP: 288 SETS



# Sparkling Water Cooler

Tabletop BST90C

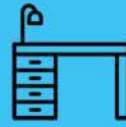

90 L/h

Ice Bank Cooling System



110-120V



220-240V



COLD



SPARKLING



AMBIENT

BST90C-CSA

Or



COLD



COLD



AMBIENT

BST90C-CCA

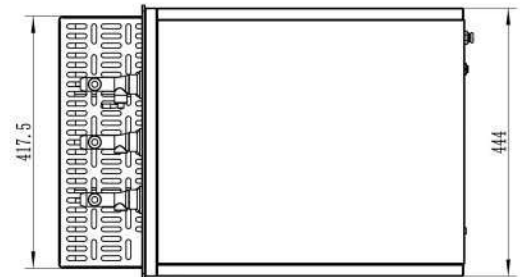
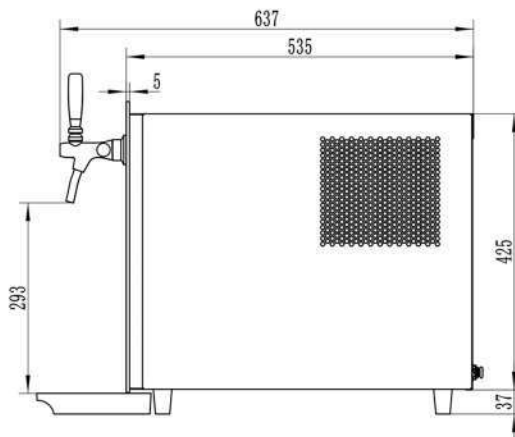
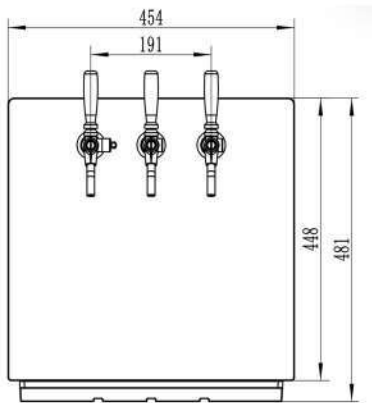

Note: The measurement is mm

## Standard Features

\*Stainless steel body with glass front panel

\*Cold still & sparkling & Ambient Or ambient and cold still water

\*R290 or R134a refrigerant

Model No.: BST90C

Compressor Power: 1/4 HP

Ice Bank Tank Volume: 18 L

Sparkling Water Tank Volume: 1.8 L

Cooling Capacity: 90 L/h

Cold Water Temperature: 4-12 Degree Centigrade

Product Size: D53.5\*W45.5\*H48CM

Packing Dimension: L63\*W50\*H56CM

20FT: 144pcs, 40FT/40HQ: 288pcs

NW:38KG

GW: 41KG

# Sparkling Water Cooler

Undercounter BSD90A

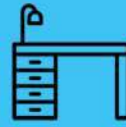

Optional



220-240V



110-120V

## 90 L/h

## Ice Bank Cooling System



COLD



SPARKLING



AMBIENT

BSD90A-CSA

Or



COLD



COLD



AMBIENT

BSD90A-CCA

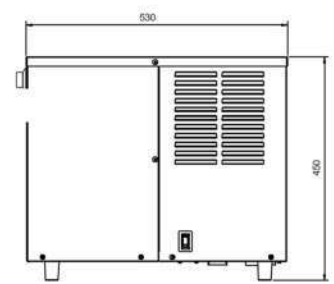
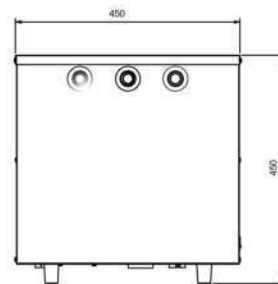
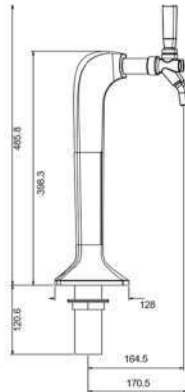
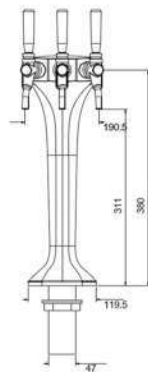

Note: The measurement is mm

## Standard Features

- \* Cold still & sparkling & Ambient  
Or ambient and cold still water
- \* Iron sheet with color painting
- \* R290 or R134a refrigerant

Model No.: BSD90A

Compressor Power: 1/4 HP

Ice Bank Tank Volume: 18 L

Sparkling Water Tank Volume: 1.8 L

Cooling Capacity: 90 L/h

Cold Water Temperature: 4-12 Degree Centigrade

Product Size: D53\*W45\*H45cm

Packing Dimension: L63\*W50\*H56cm

NW: 34kg

GW: 37kg

20FT: 144 sets

40FT/40HQ: 288 sets





## Ningbo Qiangxin Intelligent Technology Co.,Ltd.

No.6 Fachang Road, Meilin Street, Ninghai County,  
Ningbo City, Zhejiang Province, China

Cell (WeChat ): +86 19106860759

What's App: +86 13868422049

E-mail: [bill@qxsoda.com](mailto:bill@qxsoda.com) Website: [www.qxsoda.com](http://www.qxsoda.com)

Bill Duan - Sales Director

