

# AL Automatic Soap Dispenser

## User Manual



Liquid sanitizer



Liquid soap/Gel



Foaming soap



CE RoHS FC



Read And Save This Instruction

## Model

### Wall Mounted

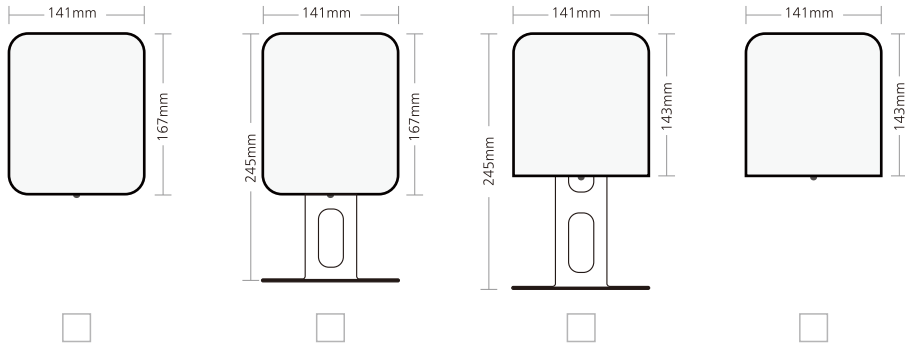

### Desktop

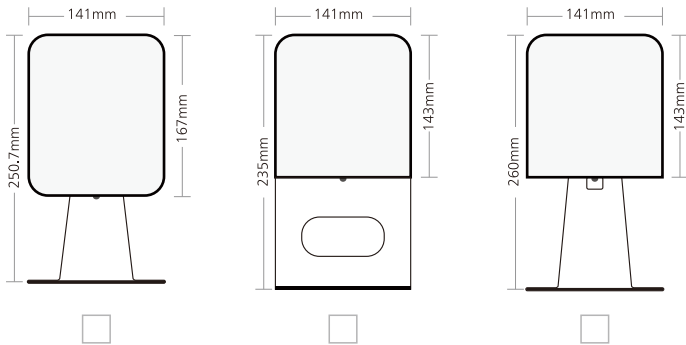

### Both available

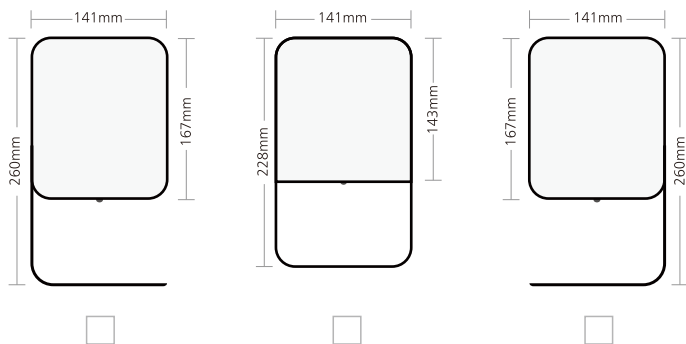

## Attention

Read this manual thoroughly and carefully before using the unit, ensuring safety and proper function. Please keep it well for later reference

## Tank Material

ABS

PC

## Overview

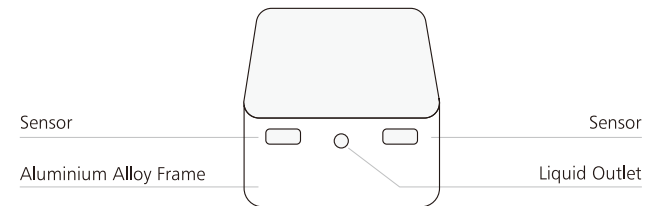
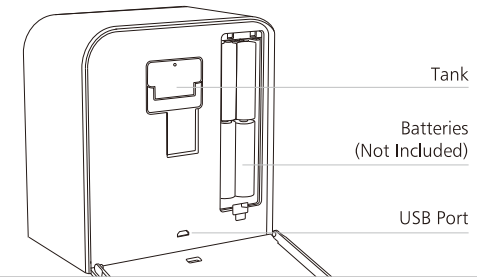
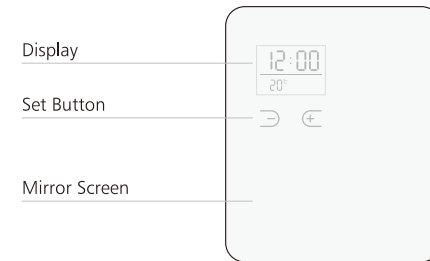

## Operating Guide

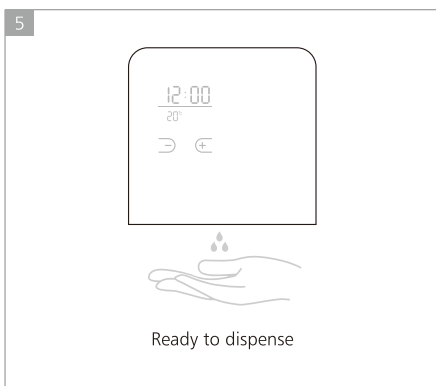
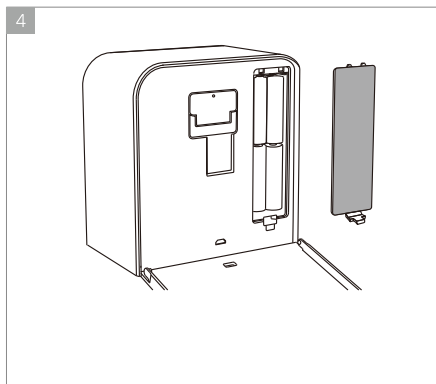
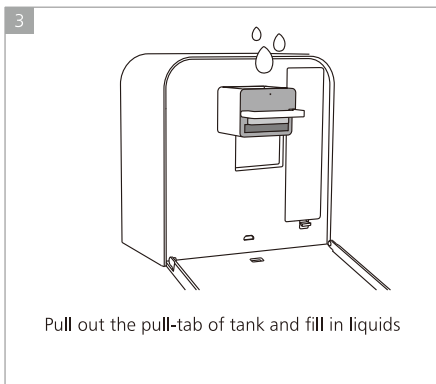
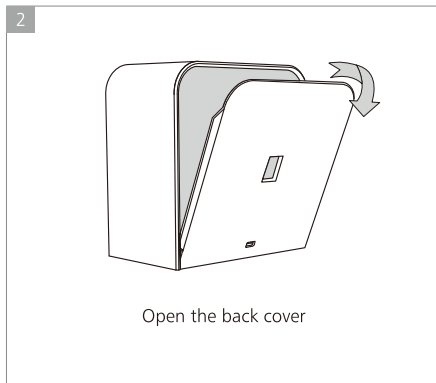
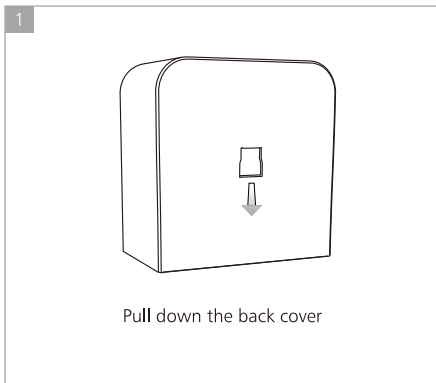

## Installation

### Option 1) Wall mounted

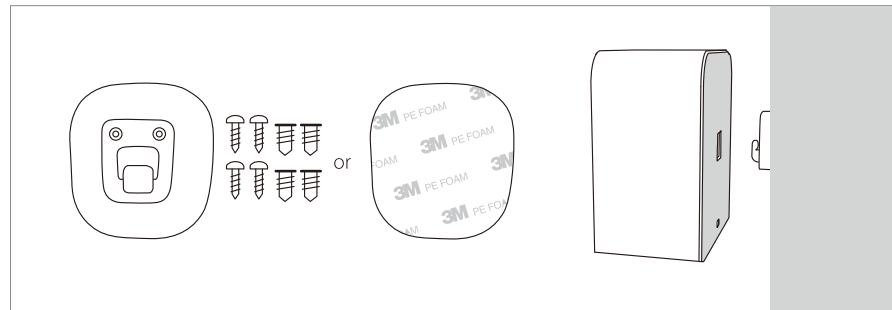

Screw the hook to the wall, and hang on the unit to the hook (recommended)  
Or stick the hook to the wall with 3M PE foam tape, and after 24 hours hang on the unit to the hook.

### Option 2) Desktop

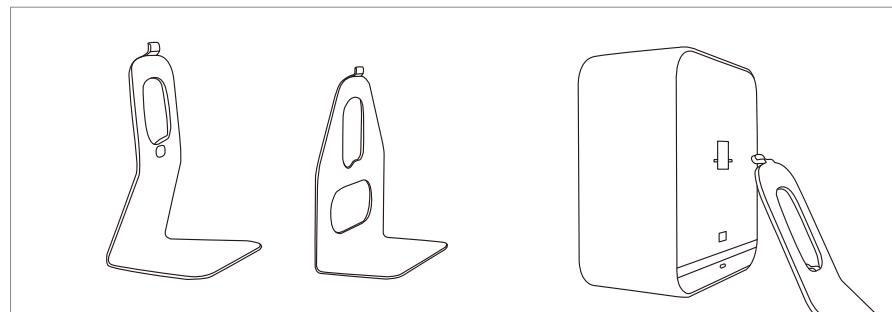

It is desktop or can be desktop by matching the holder with unit on the back.

## Technical Parameter

- Main Material: Aluminium Alloy (shell), ABS (back cover), ABS or PC (inner tank), 316 stainless steel (battery connector)
- Capacity: 480ml
- Power supply: 4 x 1.5 V LR6 AA Batteries or USB (6V1A)  
(When powered by USB, the screen is always on  
When powered by batteries, the screen will be off after 10s )
- Dispensing time (5 Level): 0.3/0.6/0.9/1.2/1.5s
- Dispensing mode: Liquid drop/Spray/Foaming
- Inductive Area: approximate 2-6CM (from outlet)
- Installation: Desktop/wall mounted

## Setup The Digital Display

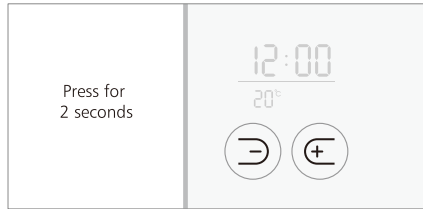

- 1) Touch "+" and "-" together for 2s to begin to set.
- 2) Touch "+" or "-" to choose 12-hour or 24-hour system.
- 3) Touch "+" and "-" together for 1s to confirm "time system" setting and it goes to "HOUR" setting
- 4) Touch "+" or "-" to set "HOUR", and touch "+" and "-" together for 1s to confirm the setting, and it goes to "MINUTE" setting.
- 5) Touch "+" or "-" to set "MINUTE", and touch "+" and

and "-" together for 1s to confirm the set, and it goes to "TEMPERATURE ID" setting.

6) Touch "+" or "-" to choose °C or °F, and touch "+" and "-" together for 1s to confirm the setting.

Tips: You have to go through all steps to make every setting effective, or the setting would not be confirmed.

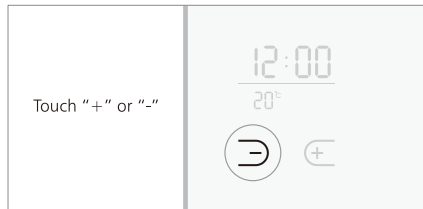

When setting confirmed, touch "+" or "-" to adjust the dispensing time(0.3/0.6/0.9/1.2/1.5s).

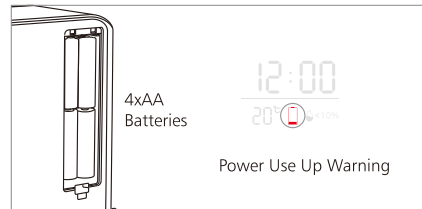

If powered by batteries, when batteries power < 10%, the power mark will be shines red, and please replace all 4 AA batteries.

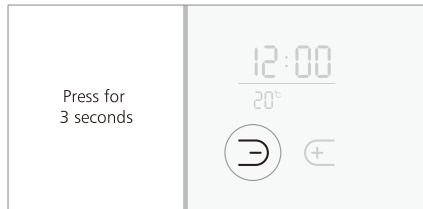

Touch "-" for 3s to empty the tank to avoid blocking if you will not use this machine for over 7 days. And touch "+" or "-" to stop it.

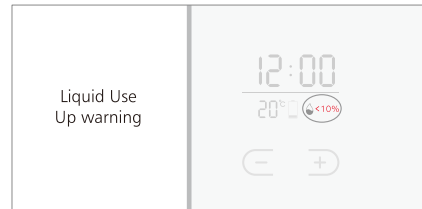

When liquids < 10%, the liquids mark will be shines red, and please refill liquids in.

Note: The liquid level sensor might be failed when you fill gel into the unit.

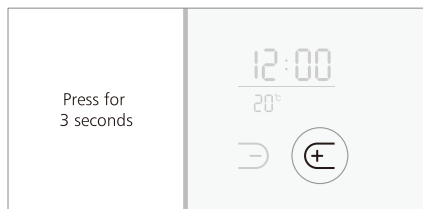

Touch "+" for 3s to power on/off

## Caution (Please Read Carefully Before Use)

- If the tank of unit is made from PC, then you can fill with liquid of alcoholic content; If the tank of unit is made from ABS, it is only designed for alcohol-free PH neutral liquid/foam soap.
- The liquid level sensor might be failed when you fill gel into the unit.
- Never fill the tank with flammable liquids or harsh chemicals.
- Keep the unit dry. Clean it with a damp cloth. Don't spray it with water.
- Do not use the unit in the shower.
- Do not submerge the unit in water or any kind of fluid.
- Do not place the unit under any mechanical stress.
- Do not put things on the unit, or it may drop.
- Please handle the unit carefully. Jolts, impacts or falls, even from a low height can damage the unit.
- Do not expose the unit to direct sunlight, heat sources, excessive humidity or corrosive environments.
- Do not mix new batteries with old ones or different brands.
- If does not use the unit for over a week, please empty the liquids inside to avoid blocking.
- If does not use the unit for long time, please cut off power supply or take out the batteries.
- Keep the unit away from children, infants, and pets, this is not a toy.
- If the batteries leak, Do not allow battery fluid to come into contact with the skin or eyes. If any contact has been made, wash the affected area with copious amounts of water and seek medical advise.
- Only a professional or authorized repairman should repair the unit.

PROBLEM	PRIMARY CAUSE	SOLUTION
Not Powering	1) The batteries use up. 2) The batteries insert incorrectly 3) The USB cable interface is loose	1) Replace new 4 AA batteries. 2) Re-insert batteries in correct way. 3) Re-set the USB cable or replace new USB cable.
Powering but not Sensing	1) The sensor area is dirty. 2) The hands is not in the sensing area.	1) Turn the unit off. Clean the sensor area with a damp sponge or doth (Do not use soap). Dry with a towel, then turn unit back ON. 2) Put hands in the sensing area. It is about 2-6cm (from outlet)
Sensing but not dispensing	1) The unit has not been used for a long time. 2) The soap is too thick. 3) It is blocked.	1) Touch "-" button for 3s to go into self-clean function, and wait until soap out. And touch "+" or "-" to end the function, and operate normally. 2) Suggest to add some water to make it thinner. Set to level 5 by pressing "+". 3) Turn the unit off, and add some hot water into the tank. Wait for hours, then shake it. Turn the unit back ON and touch "-" button for 3s to go into self-clean function, and wait until liquid out, and operate normally.

If the above actions do not work, call your dealer to inspect it and repair it if necessary.

## Packing List

